

## TECHNICAL CATALOGUE

### MONO SPLIT

RAK-25RXE  
RAK-35RXE  
RAK-50RXE



RAC-25WXEN  
RAC-35WXEN

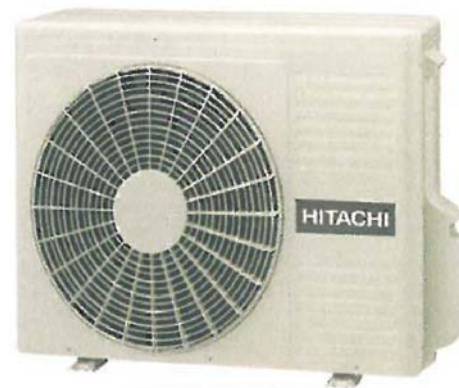

RAC-50WXEN



# HITACHI

**Specifications in this catalogue are subject to change without prior notice in order for HITACHI to bring in the latest innovations to their customers**

**Whilst every effort is made to ensure that all dimensions and specifications are correct, any printers' error not rectified are outside the control of HITACHI, who cannot be held responsible for the same**

# CONTENTS

<b>CONTENTS</b>	<b>1</b>
<b>1 SPECIFICATIONS</b>	<b>2</b>
1.1. WALL TYPE (RAK-25RXE/35RXE/50RXE)	2
1.2. WALLTYPE (RAC-25WXEN/35WXEN/50WXEN)	3
<b>2 DIMENSIONAL DATA</b>	<b>4</b>
2.1. WALL TYPE: RAK-25RXE/35RXE/50RXE	4
2.2. WALL TYPE: RAC-25WXEN/35WXEN	5
2.3. WALL TYPE: RAC-50WXEN	6
<b>3 CAPACITIES TABLE</b>	<b>7</b>
3.1. CAPACITY CHARACTERISTIC CURVES	7
3.1.1. RAK-25RXE/RAC-25WXEN	7
3.1.2. RAK-35RXE/RAC-35WXEN	8
3.1.3. RAK-50RXE/RAC-50WXEN	8
3.2. CORRECTION FACTORS ACCORDING TO PIPING LENGTH	9
3.3. CORRECTION FACTORS ACCORDING TO DEFROSTING OPERATION	11
<b>4 SOUND DATA</b>	<b>12</b>
4.1. RAC-25WXEN	12
4.2. RAC-35WXEN	13
4.3. RAC-50WXEN	14
<b>5 WORKING RANGE</b>	<b>15</b>
5.1. POWER SUPPLY	15
5.2. WORKING RANGE	15
<b>6 ELECTRICAL DATA</b>	<b>16</b>
6.1. INDOOR UNIT	16
6.2. OUTDOOR UNIT	16
<b>7 WIRING DIAGRAM</b>	<b>17</b>
7.1. RAK-25RXE, RAK-35RXE, RAK-50RXE	17
7.2. RAC-25WXEN, RAC-35WXEN, RAC-50WXEN	18
<b>8 REFRIGERANT CYCLE</b>	<b>19</b>
8.1. WALL TYPE: RAK-25RXE/RAC-25WXEN, RAK-35RXE/RAC-35WXEN	19
8.2. WALL TYPE: RAK-50RXE/RAC-50WXEN	19
<b>9 CONTROL AND FUNCTION</b>	<b>20</b>
9.1. WIRELESS REMOTE CONTROL FUNCTION	20
9.2. AUTO CHANGEOVER	21
9.3. SHIFT VALUE	21
9.4. OPERATION LOCK	22
9.5. SETTING THE PREVENTION OF MUTUAL INTERFERENCE	22
9.6. INTERMITTENT FAN SPEED SETTING	23
9.7. FAN SPEED SETTING IN THERMO OFF IN COOLING	24
9.8. ERROR CODE INFORMATION	25
9.9. ADDITIONAL FUNCTION VIA DIP-SWITCH SETTINGS	26
9.9.1. AUTO RESTART FUNCTION	26
9.9.2. HEATING/COOLING ONLY MODEL SELECTION	26
<b>10 OPTION LIST</b>	<b>27</b>
10.1. WIRED REMOTE CONTROL – SPX-RCDB	27
10.1.1. SHIFT VALUE	27
10.1.2. ERROR CODE INFORMATION	28
10.2. H-LINK ADAPTOR – PSC 6RAD	30
10.2.1. SAFETY SUMMARY	30
10.2.2. INSTALLATION WORK	30
10.2.3. ELECTRICAL WIRING	31
10.2.4. DIP SWITCH SETTING	32
10.2.5. TEST RUN	33
10.3. DRY CONTACT (SPX-WDC3) APPLICATION (USING DIP SWITCH)	34
10.4. DISTRIBUTOR – SPX-DST1	36

# 1 SPECIFICATIONS

## 1.1. WALL TYPE (RAK-25RXE/35RXE/50RXE)

INDOOR	Unit	RAK-25RXE	RAK-35RXE	RAK-50RXE
Nominal capacity adjustable		no	no	no
Nominal Cooling capacity (min - max)	kW	2.50 (0.90 - 3.10)	3.50 (0.90- 4.00)	5.00 (1.90- 5.20)
Cooling sensible capacity	kW	2.26	2.92	3.79
Nominal Heating capacity (min - max)	kW	3.20 (0.90- 4.20)	4.00 (0.90- 4.80)	5.80 (2.20- 7.00)
Noise level cooling (sound pressure) (SL / L / M / H)	dB(A)	20/27/35/43	22/29/37/45	25/31/39/47
Noise level heating (sound pressure) (SL / L / M / H)	dB(A)	20/28/36/43	22/30/37/45	25/31/39/48
Noise level (sound power)	dB(A)	58	60	60
Air flow cooling mode (SL / L / M / H)	m <sup>3</sup> /h	300/330/510/600	320/340/520/660	350/400/580/720
Air flow heating mode (SL / L / M / H)	m <sup>3</sup> /h	290/370/560/680	310/380/570/720	350/420/620/800
Fan Motor	W	30	30	30
Dehumidification	l/h	1.4	1.6	2
Dimensions (H x W x D)	mm	295 x 900 x 210	295 x 900 x 210	295 x 900 x 210
Weight	kg	11	11	11
Colour		White (N9.5)	White (N9.5)	White (N9.5)
Condensate Drain	mm	φ 16	φ 16	φ 16
Running current (C/H)	A	1.09-4.35/1.09-5.22	1.09-6.09/1.09-6.96	2.17-9.13/2.17-11.74
Power supply		220-230V	220-230V	220-230V
Cable section (interconnection)	mm <sup>2</sup>	1.50x 3+EARTH/-	1.50x 3+EARTH/-	2.50x 3+EARTH/-
Piping diameter (Liq / Gas)	Inch	1/4" / 3/8"	1/4" / 3/8"	1/4" / 1/2"
Drain diameter (ext)	mm	φ 16	φ 16	φ 16
Remote control (standard/optional)		RAR-6NE1/SPX-RCDB	RAR-6NE1/SPX-RCDB	RAR-6NE1/SPX-RCDB
<b>Filter</b>				
ACL Filter Optional		activated carbon	activated carbon	activated carbon
ACL part name		SPX-CFH25	SPX-CFH25	SPX-CFH25
Pre-filter(Standard/Optional)		STAINLESS/-	STAINLESS/-	STAINLESS/-

### NOTE:

1. The nominal cooling and heating capacity is the combined capacity of the HITACHI standard split system, and are based on the ISO 5151.

Operation Conditions		Cooling	Heating
Indoor Air Inlet Temperature	dB	27.0 °C	20.0 °C
	WB	19.0 °C	15.0 °C
Outdoor Air Inlet Temperature	dB	35.0 °C	7.0 °C
	WB	24.0 °C	6.0 °C
Piping Length: 5.0 meters; Piping Lift: 0 meter dB: Dry Bulb; WB: Wet Bulb			

2. The Sound Pressure Level is based on the following conditions:

- 0.8 meter beneath indoor height center
- 1 meter from Discharge grille

The above data was measured in an anechoic chamber. Please take into consideration reflected sound of your specific site

## 1.2. WALL TYPE (RAC-25WXEN/35WXEN/50WXEN)

OUTDOOR	Unit	RAC-25WXEN	RAC-35WXEN	RAC-50WXEN	
Nominal Cooling capacity (min - max)	kW	2.50 (0.90 - 3.10)	3.50 (0.90- 4.00)	5.00 (1.90- 5.20)	
Nominal Heating capacity (min - max)	kW	3.20 (0.90- 4.20)	4.00 (0.90- 4.80)	5.80 (2.20- 7.00)	
Nominal cooling power input (min - max)	kW	0.481 (0.25 - 1.00)	0.814 (0.25 - 1.40)	1.397 (0.50 - 2.10)	
Nominal heating power input (min - max)	kW	0.593(0.25 - 1.20)	0.800(0.25 - 1.60)	1.415(0.50 - 2.70)	
EER / COP		5.20/5.40	4.30/5.00	3.58/4.10	
SEER / SCOP		8.50/5.20	8.70/5.20	7.50/4.70	
Energy class (SEER/SCOP)		A+++/A+++	A+++/A+++	A+/A++	
Noise level cooling (sound pressure)	dB(A)	47	48	51	
Noise level heating (sound pressure)	dB(A)	48	50	51	
Noise level (sound power)	dB(A)	61	62	65	
Air flow (Cooling / Heating)	m <sup>3</sup> /h	1860 / 1620	1920 / 1620	2160 / 2160	
Dimensions (H x W x D)	mm	600x792x299	600x792x299	736× 800× 350	
Weight	kg	38.2	38.2	51.7	
Colour (Munsell Code)		Beige (5Y7/2)	Beige (5Y7/2)	Beige (5Y7/2)	
Power supply	V/Ph/Hz	230V / 1Ph / 50Hz	230V / 1Ph / 50Hz	230V / 1Ph / 50Hz	
Recommended fuse size	A	25	25	25	
Starting current(C/H)	A	2.92/2.73	3.86/3.67	6.36/6.44	
Running current (C/H)	A	1.09-4.35/1.09-5.22	1.09-6.09/1.09-6.96	2.17-9.13/2.17-11.74	
Cable section (power)	mm <sup>2</sup>	1.50x 2+EARTH	1.50x 2+EARTH	2.50x 2+EARTH	
Cable section (Interconnection)	mm <sup>2</sup>	1.50x 3+EARTH	1.50x 3+EARTH	2.50x 3+EARTH	
Piping diameter (Liq / Gas)	Inch	1/4" / 3/8"	1/4" / 3/8"	1/4" / 1/2"	
Minimum piping length	m	3	3	3	
Maximum piping length / height difference	m	20 / 10	20 / 10	30/10	
Current quantity of refrigerant / Chargeless	kg	0.98	0.98	1.30	
Chargeless length / Additional refrigerant charge	m / g/m	20/-	20/-	30/-	
Working range (cooling / heating)	°C	-10°C—43°C/-25°C—21°C	-10°C—43°C/-25°C—21°C	-10°C—43°C/-25°C—21°C	
Refrigerant		R32	R32	R32	
Condenser Fan		Propeller Fan	Propeller Fan	Propeller Fan	
Compressor	Type		ROTARY	ROTARY	2 Cylinder Rotary
	Oil Charge	mL	320±20	320±20	480±20
	Oil Type		ACS-68R or equivalent	ACS-68R or equivalent	ACS-68R or equivalent
	Coil resistance	Ω	1.354 at 20°C	1.354 at 20°C	1.354 at 20°C
	Quantity		1	1	1

### NOTE:

1. The Sound Pressure Level is based on the following conditions:

- 1 meter from the unit front surface and 1 meter from floor level

The above data was measured in an anechoic chamber. Please take into consideration reflected sound of your specific site

## 2 DIMENSIONAL DATA

### 2.1. WALL TYPE: RAK-25RXE/35RXE/50RXE

Unit : mm

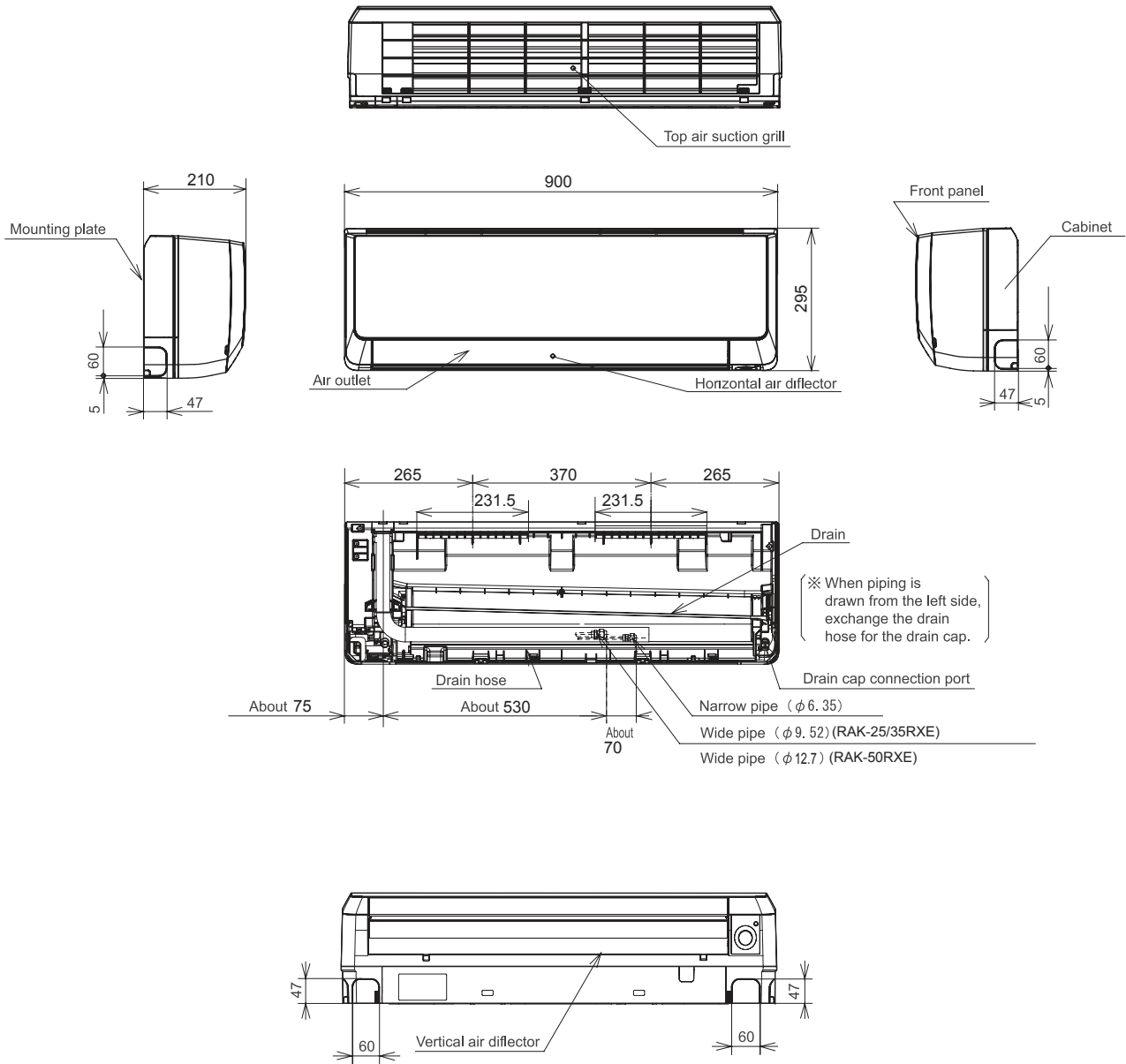

2.2. WALL TYPE:RAC-25WXEN/35WXEN

Unit : mm

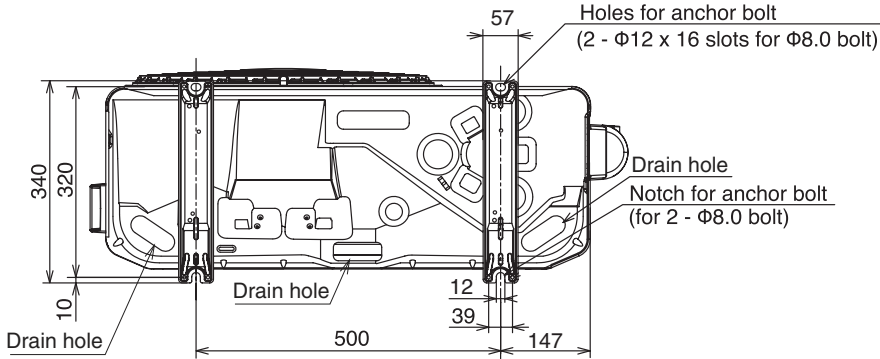
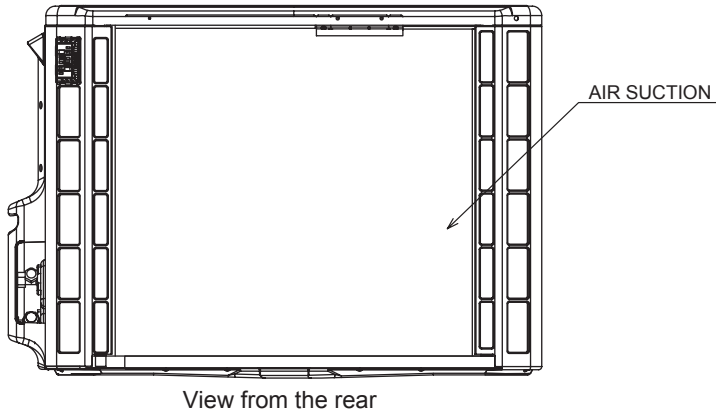
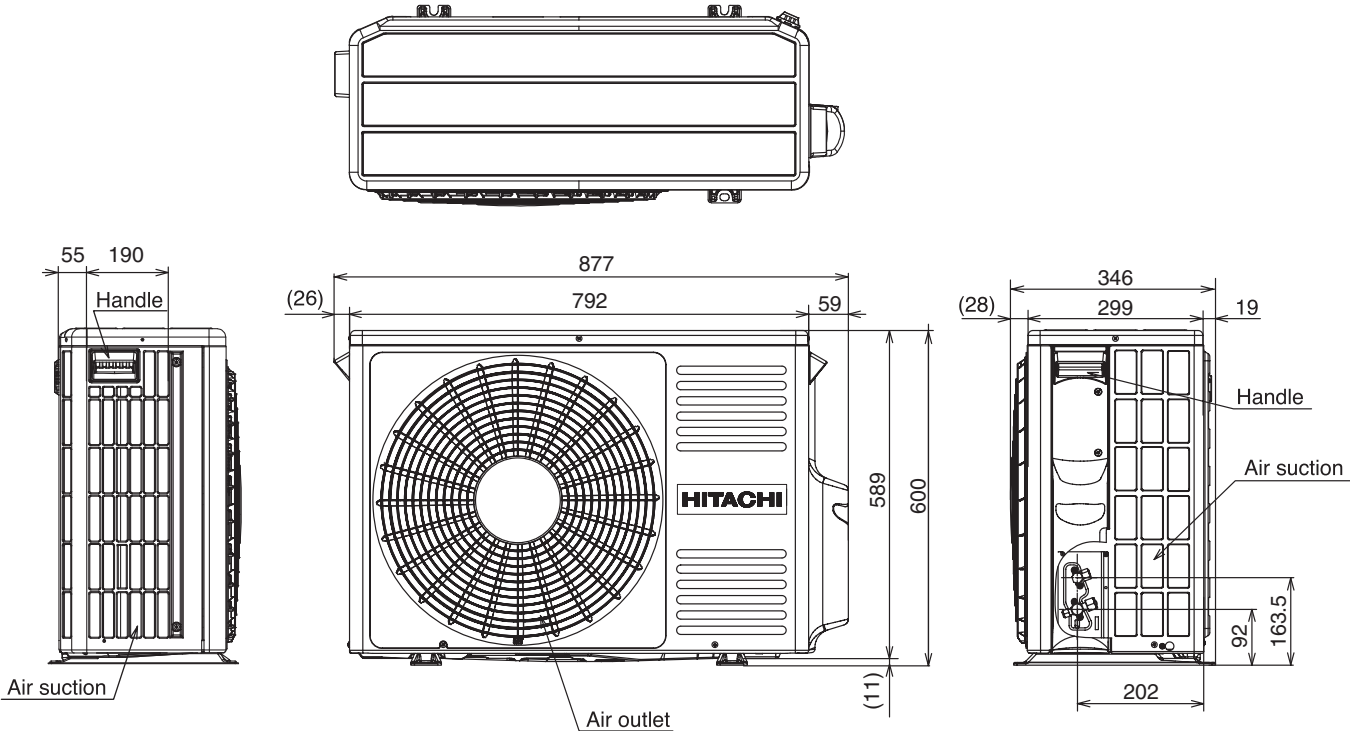

## 2.3. WALL TYPE: RAC-50WXEN

Unit : mm

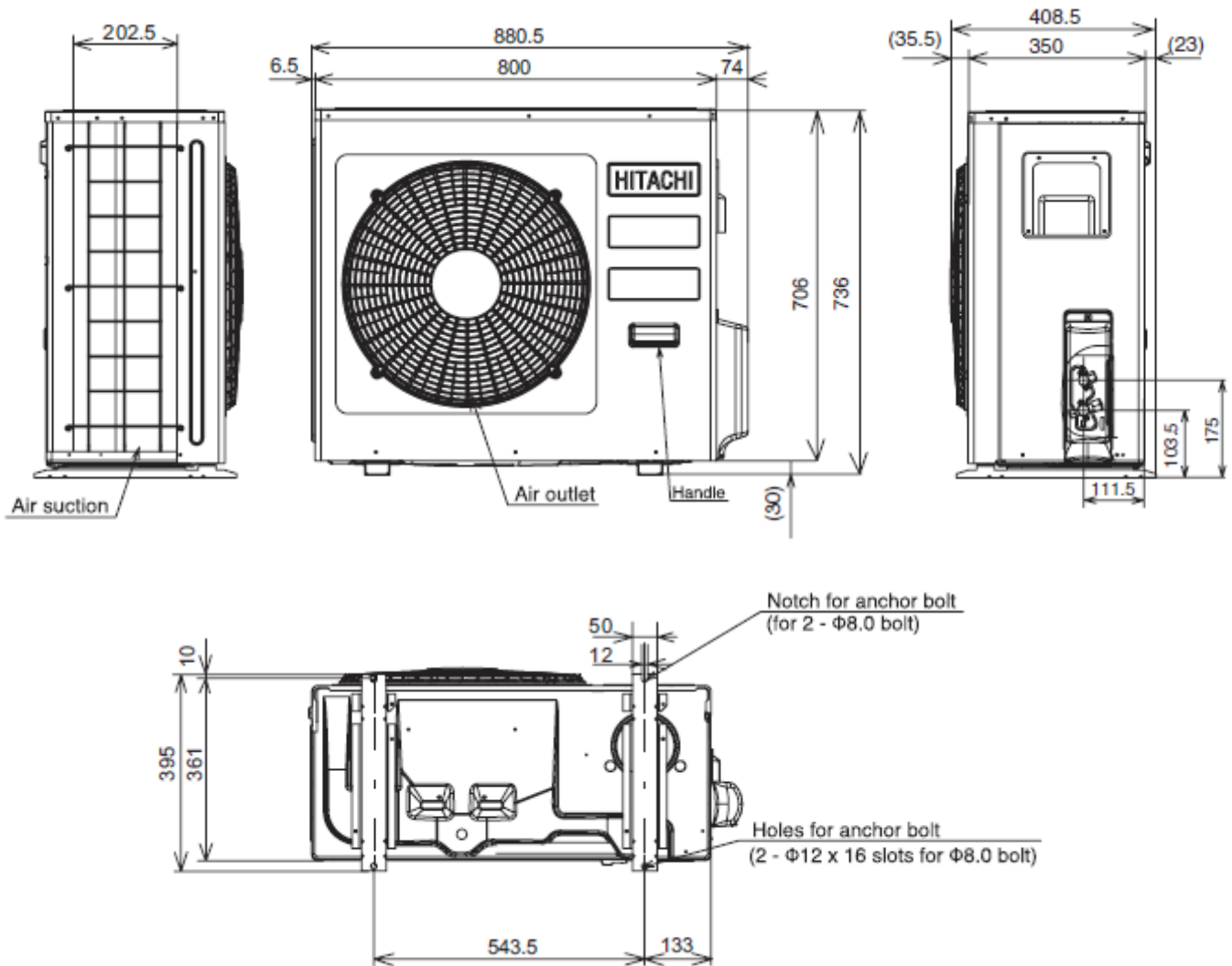



### 3 CAPACITIES TABLE

#### 3.1. CAPACITY CHARACTERISTIC CURVES

The following charts show the characteristics of outdoor unit capacity, which corresponds with the operating ambient temperature of outdoor unit.

Condition:

① Pipe length / height difference : 5m / 0m

③ Capacity loss due to white frost and defrost operation is not included.

② Indoor fan speed at High mode

##### 3.1.1 RAK-25RXE/RAC-25WXEN

### COOLING [50Hz, 230V]

INDOOR		OUTDOOR TEMPERATURE (°CDW)																				
EWB	EDB	-10			21			27			32			35			40			43		
°C	°C	TC	SHC	PI	TC	SHC	PI	TC	SHC	PI	TC	SHC	PI	TC	SHC	PI	TC	SHC	PI	TC	SHC	PI
12.0	18	1976	1679	273	2238	2238	324	2071	2066	382	2050	2057	443	1975	1966	462	1850	1853	495	1775	1763	515
14.0	20	1976	1679	273	2405	2238	324	2238	2088	386	2200	2057	447	2125	1989	467	1975	1853	500	1900	1785	524
16.0	22	1976	1786	277	2571	2238	328	2381	2088	391	2350	2057	452	2275	1989	476	2125	1853	510	2050	1785	529
18.0	25	2119	1916	281	2738	2432	332	2524	2260	395	2500	2237	457	2400	2147	476	2250	2011	515	2150	1921	534
19.0	27	2190	1980	285	2833	2561	337	2619	2368	400	2600	2350	462	2500	2260	481	2350	2124	515	2250	2034	534
22.0	30	2429	1959	285	3143	2540	337	2905	2346	400	2875	2328	467	2775	2237	486	2500	2170	534	2325	2124	563
24.0	32	2595	1959	290	3357	2540	341	3095	2346	404	3075	2328	467	2950	2237	491	2600	2215	548	2375	2192	582

### HEATING [50Hz, 230V]

INDOOR		OUTDOOR TEMPERATURE (°CDW)																					
EDB	-15	-10			-7			-5			0			7			10			15			
°C	TC	SHC	PI	TC	SHC	PI	TC	SHC	PI	TC	SHC	PI	TC	SHC	PI	TC	SHC	PI	TC	SHC	PI		
16	3168		1244	3418		1344	3560		1412	3496		1304	3349		1021	3163		648	3315		711	3541	818
18	3184		1237	3434		1337	3580		1401	3520		1290	3374		1006	3182		620	3332		682	3570	786
20	<b>3200</b>		<b>1230</b>	3450		1330	<b>3600</b>		<b>1390</b>	3543		1276	3400		992	<b>3200</b>		<b>593</b>	3350		653	3600	753
22	3216		1223	3466		1323	3620		1379	3566		1262	3426		977	3218		566	3368		624	3630	720
24	3232		1216	3482		1316	3640		1368	3589		1248	3451		962	3237		538	3385		595	3659	688

EWB : Evaporator Wet Bulb temperature (°C)

EDB : Evaporator Dry Bulb temperature (°C)

(°CDB) : Outdoor Unit Inlet Air Dry Temperature (°C)

TC : Total Capacity (W)

SHC : Sensible Heating Capacity (W)

PI : Power Input

## 3.1.2 RAK-35RXE/RAC-35WXEN

## COOLING [50Hz, 230V]

INDOOR		OUTDOOR TEMPERATURE (°CDW)																				
EWB	EDB	-10			21			27			32			35			40			43		
		°C	TC	SHC	PI	TC	SHC	PI	TC	SHC	PI	TC	SHC	PI	TC	SHC	PI	TC	SHC	PI	TC	SHC
12.0	18	2767	2169	461	3133	2892	548	2900	2670	646	2870	2657	749	2765	2540	781	2590	2394	838	2485	2278	871
14.0	20	2767	2169	461	3367	2892	548	3133	2698	653	3080	2657	757	2975	2570	790	2765	2394	847	2660	2307	887
16.0	22	2767	2308	469	3600	2892	555	3333	2698	661	3290	2657	765	3185	2570	806	2975	2394	863	2870	2307	895
18.0	25	2967	2475	476	3833	3142	562	3533	2920	669	3500	2891	773	3360	2774	806	3150	2599	871	3010	2482	904
19.0	27	3067	2558	483	3967	3309	570	3667	3059	676	3640	3037	781	3500	2920	814	3290	2745	871	3150	2628	904
22.0	30	3400	2531	483	4400	3282	570	4067	3031	676	4025	3008	790	3885	2891	822	3500	2803	904	3255	2745	952
24.0	32	3633	2531	490	4700	3282	577	4333	3031	684	4305	3008	790	4130	2891	830	3640	2862	928	3325	2832	985

## HEATING [50Hz, 230V]

INDOOR		OUTDOOR TEMPERATURE (°CDW)																							
EDB	°C	-15			-10			-7			-5			0			7			10			15		
		TC	SHC	PI	TC	SHC	PI	TC	SHC	PI	TC	SHC	PI	TC	SHC	PI	TC	SHC	PI	TC	SHC	PI	TC	SHC	PI
16	3960		1469	4335		1457	4550		1460	4456		1378	4236		1156	3954		875	4181		872	4526		869	
18	3980		1460	4355		1447	4575		1445	4485		1359	4268		1135	3977		837	4203		832	4563		824	
20	4000		1450	4375		1438	4600		1430	4514		1340	4300		1115	4000		800	4225		793	4600		780	
22	4020		1440	4395		1428	4625		1415	4543		1321	4332		1095	4023		763	4247		753	4637		736	
24	4040		1431	4415		1418	4651		1400	4572		1302	4364		1074	4046		725	4269		713	4674		691	

EWB : Evaporator Wet Bulb temperature (°C)  
 EDB : Evaporator Dry Bulb temperature (°C)  
 (°CDB) : Outdoor Unit Inlet Air Dry Temperature (°C)

TC : Total Capacity (W)  
 SHC : Sensible Heating Capacity (W)  
 PI : Power Input

## 3.1.3 RAK-50RXE/RAC-50WXEN

## COOLING [50Hz, 230V]

INDOOR		OUTDOOR TEMPERATURE (°CDW)																				
EWB	EDB	-10			21			27			32			35			40			43		
		°C	TC	SHC	PI	TC	SHC	PI	TC	SHC	PI	TC	SHC	PI	TC	SHC	PI	TC	SHC	PI	TC	SHC
12.0	18	3952	2815	792	4476	3754	940	4143	3465	1108	4100	3449	1285	3950	3297	1341	3700	3108	1439	3550	2956	1495
14.0	20	3952	2815	792	4810	3754	940	4476	3501	1121	4400	3449	1299	4250	3335	1355	3950	3108	1453	3800	2994	1523
16.0	22	3952	2996	804	5143	3754	953	4762	3501	1134	4700	3449	1313	4550	3335	1383	4250	3108	1481	4100	2994	1537
18.0	25	4238	3212	817	5476	4079	965	5048	3790	1147	5000	3752	1327	4800	3601	1383	4500	3373	1495	4300	3222	1551
19.0	27	4381	3321	829	5667	4295	978	5238	3970	1160	5200	3942	1341	5000	3790	1397	4700	3563	1495	4500	3411	1551
22.0	30	4857	3285	829	6286	4259	978	5810	3934	1160	5750	3904	1355	5550	3752	1411	5000	3638	1551	4650	3563	1634
24.0	32	5190	3285	841	6714	4259	990	6190	3934	1173	6150	3904	1355	5900	3752	1425	5200	3714	1593	4750	3676	1690

## HEATING [50Hz, 230V]

INDOOR		OUTDOOR TEMPERATURE (°CDW)																							
EDB	°C	-15			-10			-7			-5			0			7			10			15		
		TC	SHC	PI	TC	SHC	PI	TC	SHC	PI	TC	SHC	PI	TC	SHC	PI	TC	SHC	PI	TC	SHC	PI	TC	SHC	PI
16	5442		2181	5630		2212	5727		2249	5716		2149	5707		1874	5733		1537	5849		1563	5993		1610	
18	5471		2166	5659		2197	5763		2225	5758		2119	5754		1841	5767		1476	5881		1498	6046		1538	
20	5500		2150	5688		2181	5800		2200	5800		2088	5800		1808	5800		1415	5913		1434	6100		1465	
22	5529		2134	5717		2166	5837		2175	5842		2057	5846		1774	5833		1354	5944		1369	6154		1392	
24	5558		2119	5746		2150	5873		2151	5884		2026	5893		1741	5867		1293	5976		1304	6207		1320	

EWB : Evaporator Wet Bulb temperature (°C)  
 EDB : Evaporator Dry Bulb temperature (°C)  
 (°CDB) : Outdoor Unit Inlet Air Dry Temperature (°C)

TC : Total Capacity (W)  
 SHC : Sensible Heating Capacity (W)  
 PI : Power Input

### 3.2. CORRECTION FACTORS ACCORDING TO PIPING LENGTH

Correction Factor for **Cooling Capacity** according to Piping Length

The cooling capacity should be corrected according to the following formula:

$$CCA = CC \times F$$

CCA: Actual Corrected Cooling Capacity (kcal/h)

CC: Cooling Capacity in the Performance Table (kcal/h)

F: Correction Factor Based on the Equivalent Piping Length

Correction Factor for **Heating Capacity** according to Piping Length

The heating capacity should be corrected according to the following formula:

$$HCA = HC \times F$$

HCA: Actual Corrected Heating Capacity (kcal/h)

HC: Heating Capacity in the Performance Table (kcal/h)

F: Correction Factor Based on the Equivalent Piping Length

The correction factors are shown in the following figure.

Equivalent Piping Length for:

- One 90° Elbow is 0.5m.
- One 180° Curve is 1.5m.

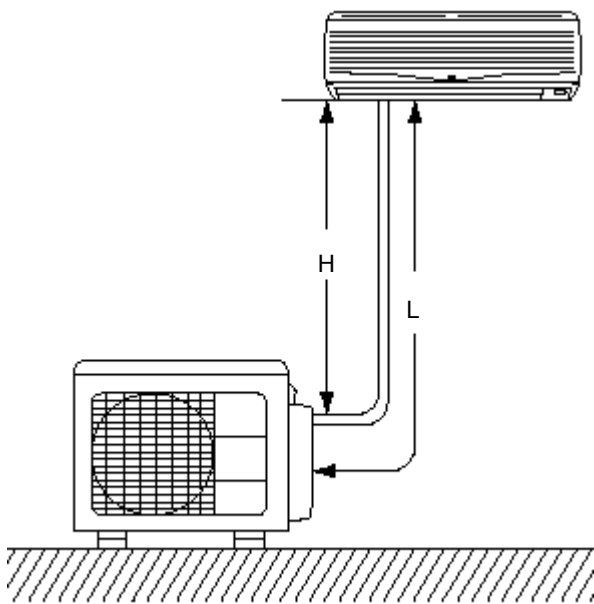

H: Vertical Distance Between Indoor Unit and Outdoor Units in Meters

L: Actual One-Way Piping Length Between Indoor Unit and Outdoor Unit in Meters

EL: Equivalent Total Distance Between Indoor Unit and Outdoor Unit in Meters (Equivalent One-Way Piping Length)

Models : RAK-25RXE/RAC-25WXEN, RAK-35RXE/RAC-35WXEN

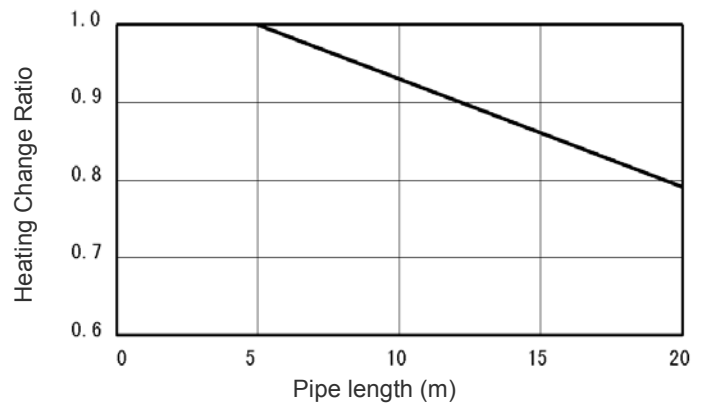
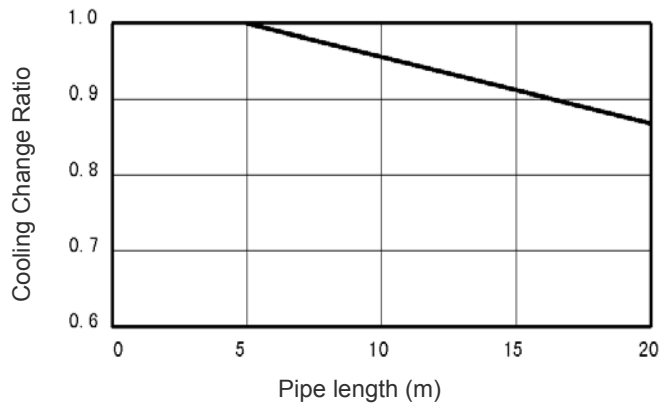

Models : RAK-50RXE/RAC-50WXEN

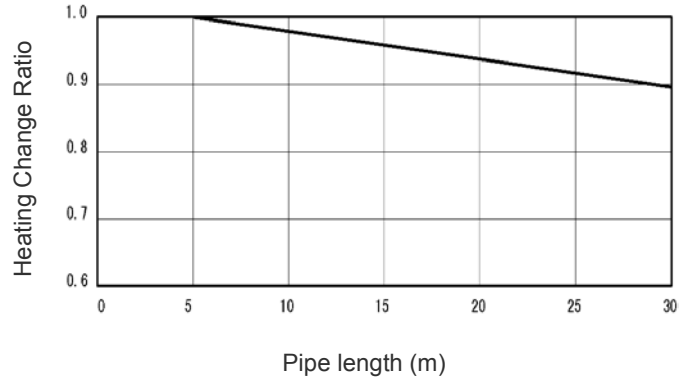
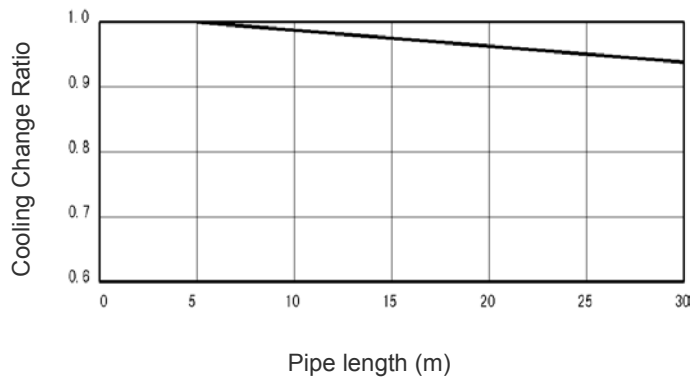

**3.3. CORRECTION FACTORS ACCORDING TO DEFROSTING OPERATION**

The heating capacity in the preceding paragraph, excludes the condition of the frost or the defrosting operation period. In consideration of the frost or the defrosting operation, the heating capacity is corrected by the equation below.

Corrected heating capacity = Defrost Correction factor x unit capacity

OUTDOOR TEMPERATURE (°CDB)	-15	-10	-7	-5	0	7	10	15
Correction factor (humidity rate85% RH)	0.95	0.95	0.89	0.85	0.81	1.0	1.0	1.0

Correction Factor

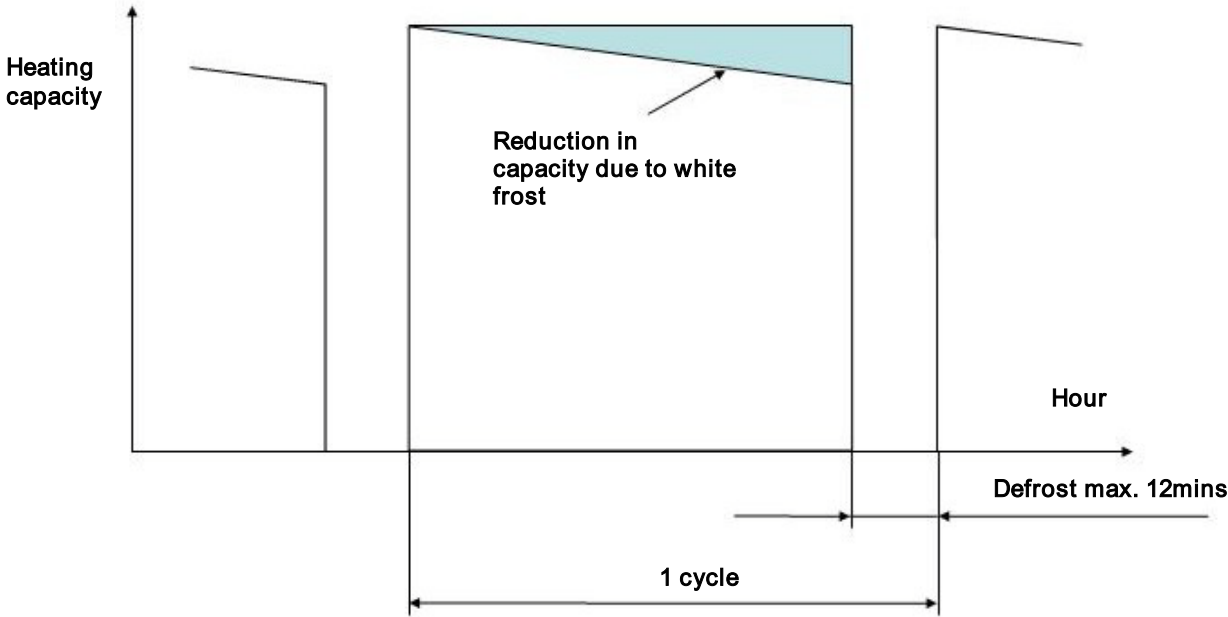

**NOTE:**  
The correction factor is not valid for special conditions such as snowfall or operation in a transitional period.

## 4 SOUND DATA

### 4.1. RAC-25WXEN

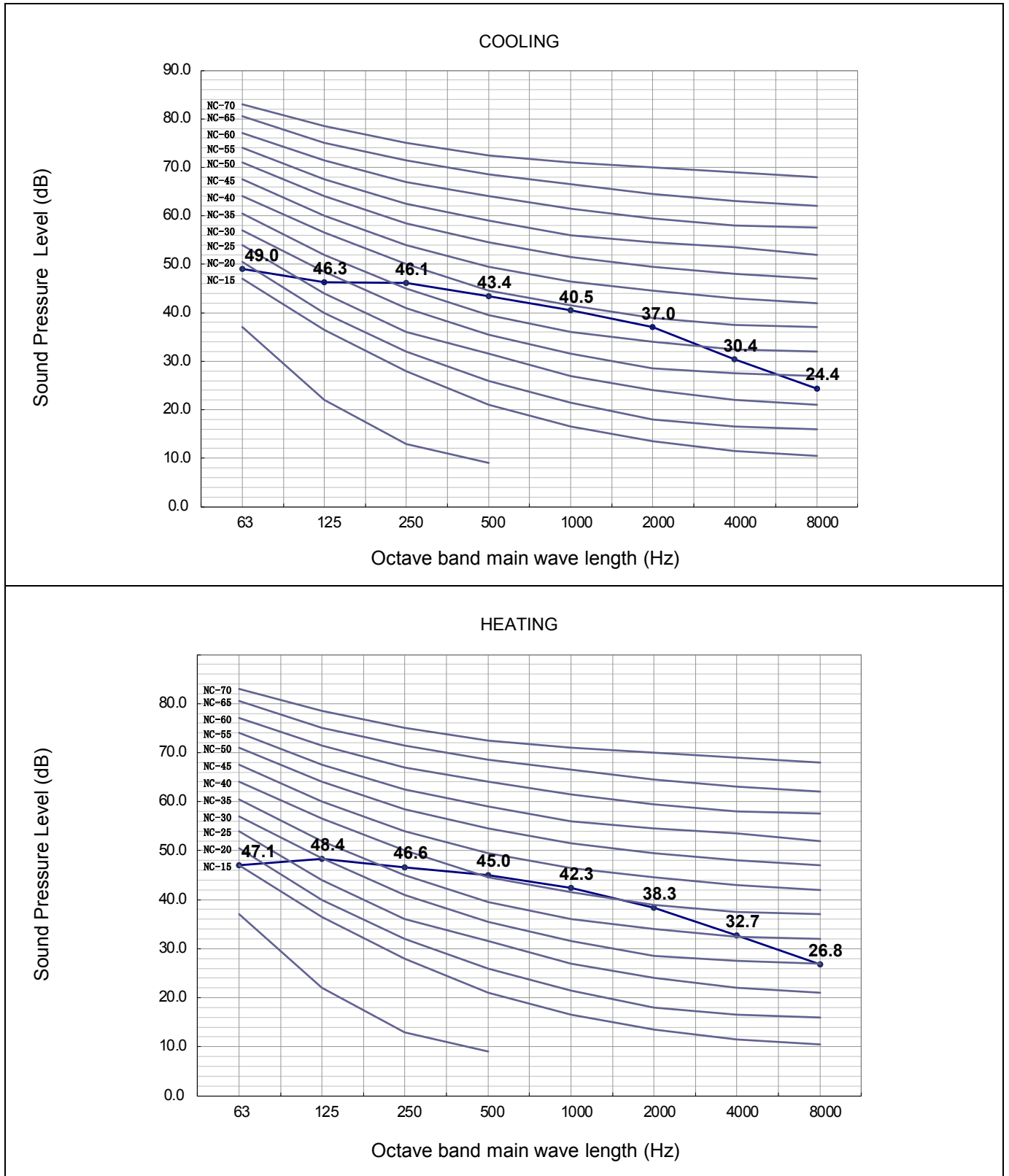

The Sound Pressure Level is based on the following conditions:

- 1 meter from the unit front surface and 1 meter from floor level

The above data was measured in an anechoic chamber. Please take into consideration reflected sound of your specific site

4.2. RAC-35WXEN

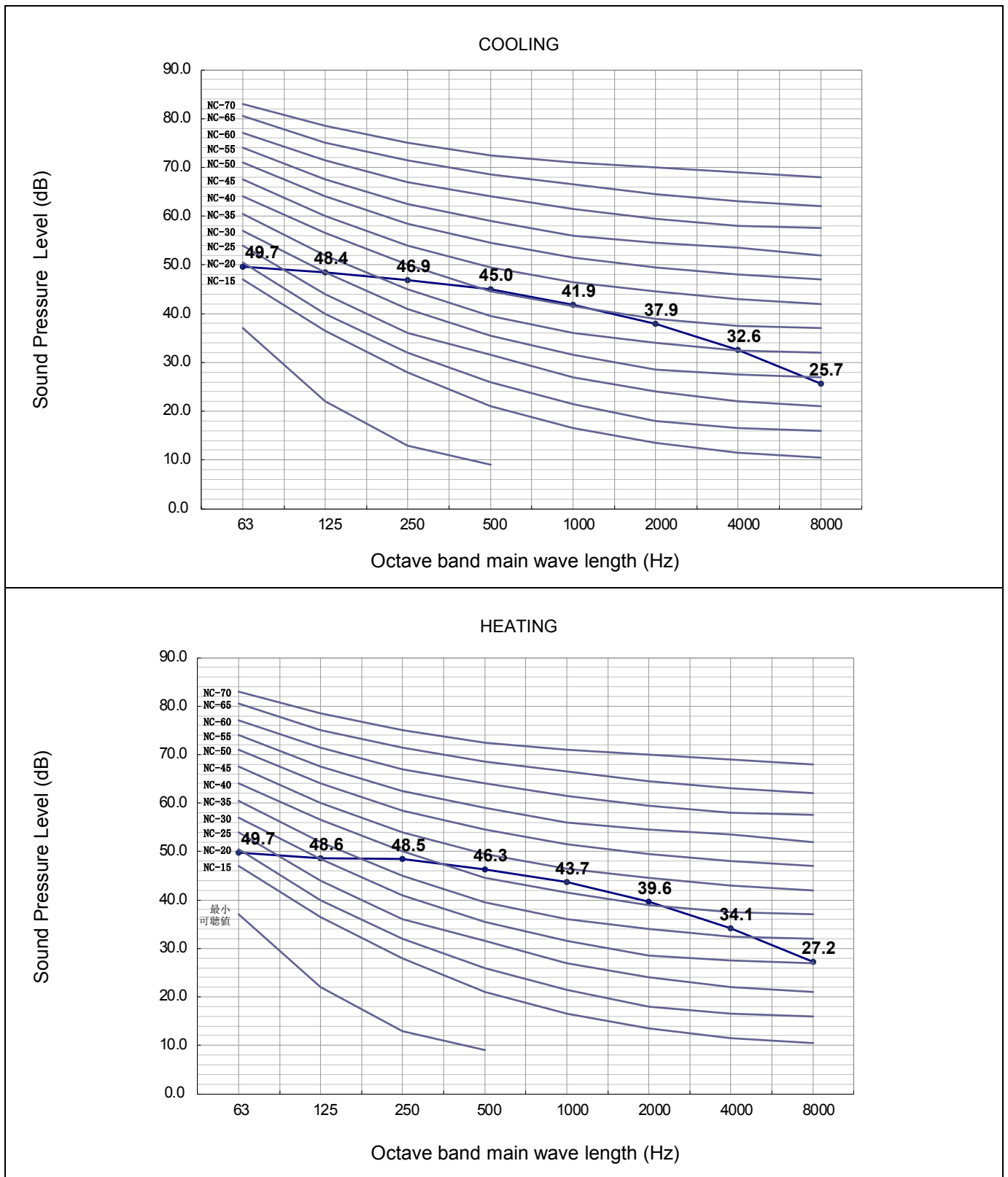

The Sound Pressure Level is based on the following conditions:

- 1 meter from the unit front surface and 1 meter from floor level

The above data was measured in an anechoic chamber. Please take into consideration reflected sound of your specific site

4.3. RAC-50WXEN

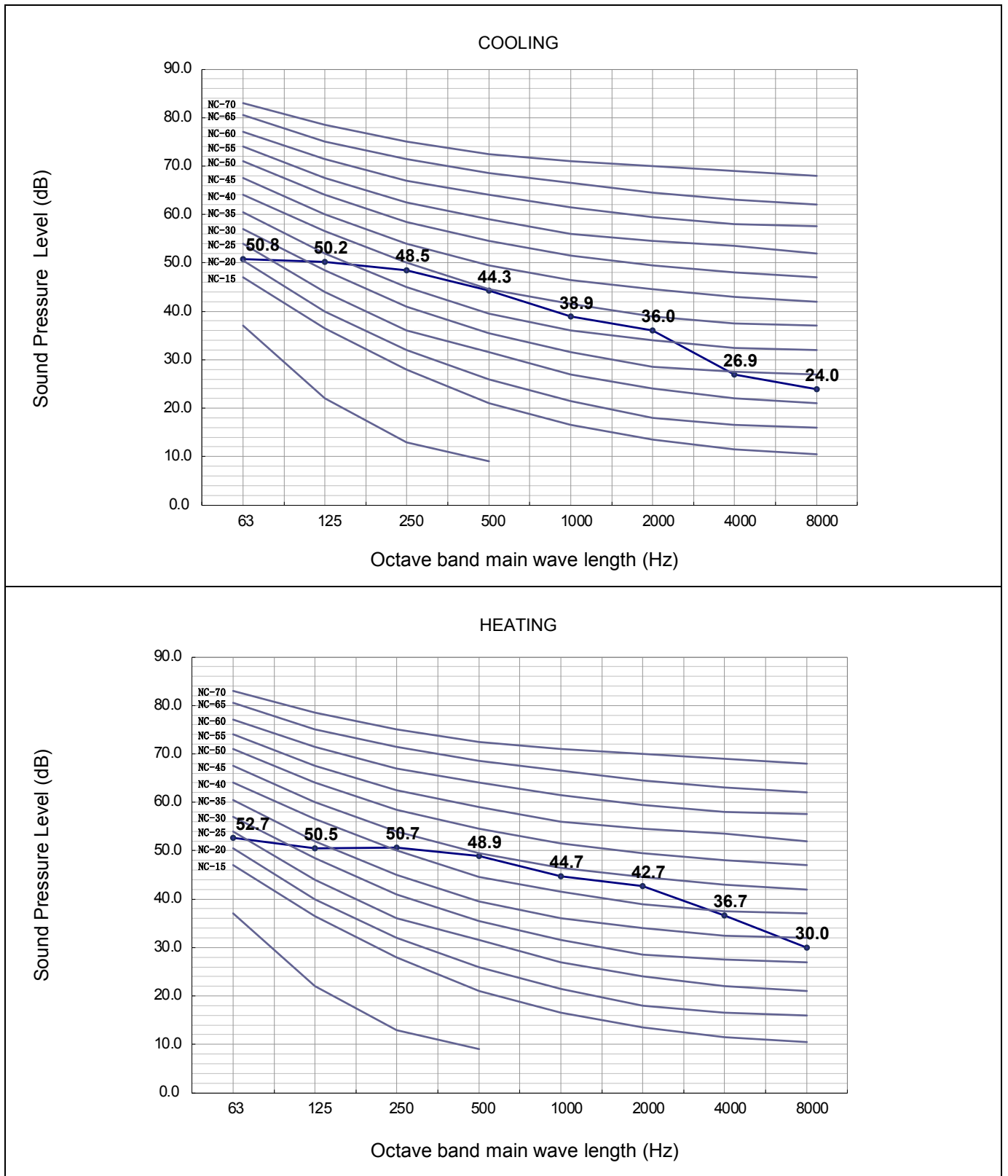

The Sound Pressure Level is based on the following conditions:

- 1 meter from the unit front surface and 1 meter from floor level

The above data was measured in an anechoic chamber. Please take into consideration reflected sound of your specific site



## 5 WORKING RANGE

### 5.1. POWER SUPPLY

Working Voltage	207V ~ 253V
Voltage Imbalance	Within a 3% Deviation from Each Voltage at the Main Terminal of Outdoor Unit
Starting Voltage	Higher than 85% of the Rated Voltage

### 5.2. WORKING RANGE

Applicable models:

RAC-25WXEN
RAC-35WXEN
RAC-50WXEN

The temperature range is indicated in the following table.

#### Cooling

working range	min (°C)	max (°C)	rated (°C)
outdoor	-10	43	35
indoor	16	43	27

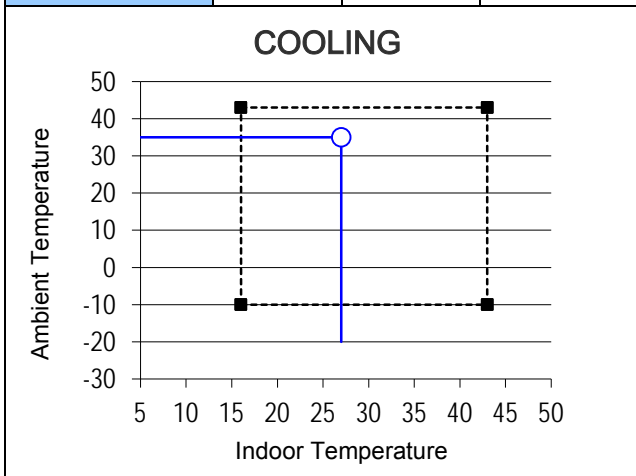

#### Heating

working range	min (°C)	max (°C)	rated (°C)
outdoor	-25	21	7
indoor	16	26	20

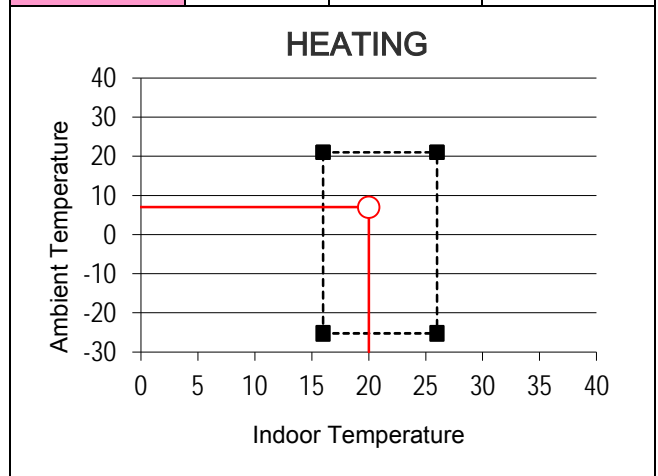

## 6 ELECTRICAL DATA

### 6.1. INDOOR UNIT

Model	Unit Main Power		Applicable Current		Indoor Fan Motor	
	VOL, PH, Hz	Fuse Rating (A)	STC	RNC	RNC	IPT
RAK-25RXE	230,1, 50	3.15	(C) 2.92 (H)2.73	(C) 4.35 (H)5.22	0.67	30
RAK-35RXE	230,1, 50	3.15	(C) 3.86 (H)3.67	(C) 6.09 (H)6.96	0.67	30
RAK-50RXE	230,1, 50	3.15	(C) 6.36 (H)6.44	(C) 9.13 (H)11.74	0.67	30

VOL: Rated Unit Power Supply Voltage (V)  
 Hz: Frequency (Hz)  
 STC: Starting Current (A)

RNC: Running Current (A)  
 PH: Phase ( $\phi$ )  
 IPT: Input (W)

### 6.2. OUTDOOR UNIT

Model	Unit Main Power				Compressor Motor					
	VOL, PH, Hz	Fuse Rating (A)	Min (V)	Max (V)	Locked Rotor Ampere (A)	STC	Cooling Operation		Heating Operation	
							RNC	IPT	RNC	IPT
RAC-25WXEN	230,1, 50	25	207	253	-	2.73	4.35	481	5.22	593
RAC-35WXEN	230,1, 50	25	207	253	-	3.67	6.09	814	6.96	800
RAC-50WXEN	230,1, 50	25	207	253	-	6.44	9.13	1397	11.74	1415

VOL: Rated Unit Power Supply Voltage (V)  
 HZ: Frequency (Hz)  
 STC: Starting Current (A)

RNC: Running Current (A)  
 PH: Phase ( $\phi$ )  
 IPT: Input (W)

**NOTE:**

1. The above compressor data is based on 100% capacity combination of indoor units at the rated operating frequency
2. This data is based on the same conditions as the nominal heating and cooling capacities.
3. The compressor started by an inverter, resulting in extremely low starting current.

7 WIRING DIAGRAM

7.1. RAK-25RXE, RAK-35RXE, RAK-50RXE

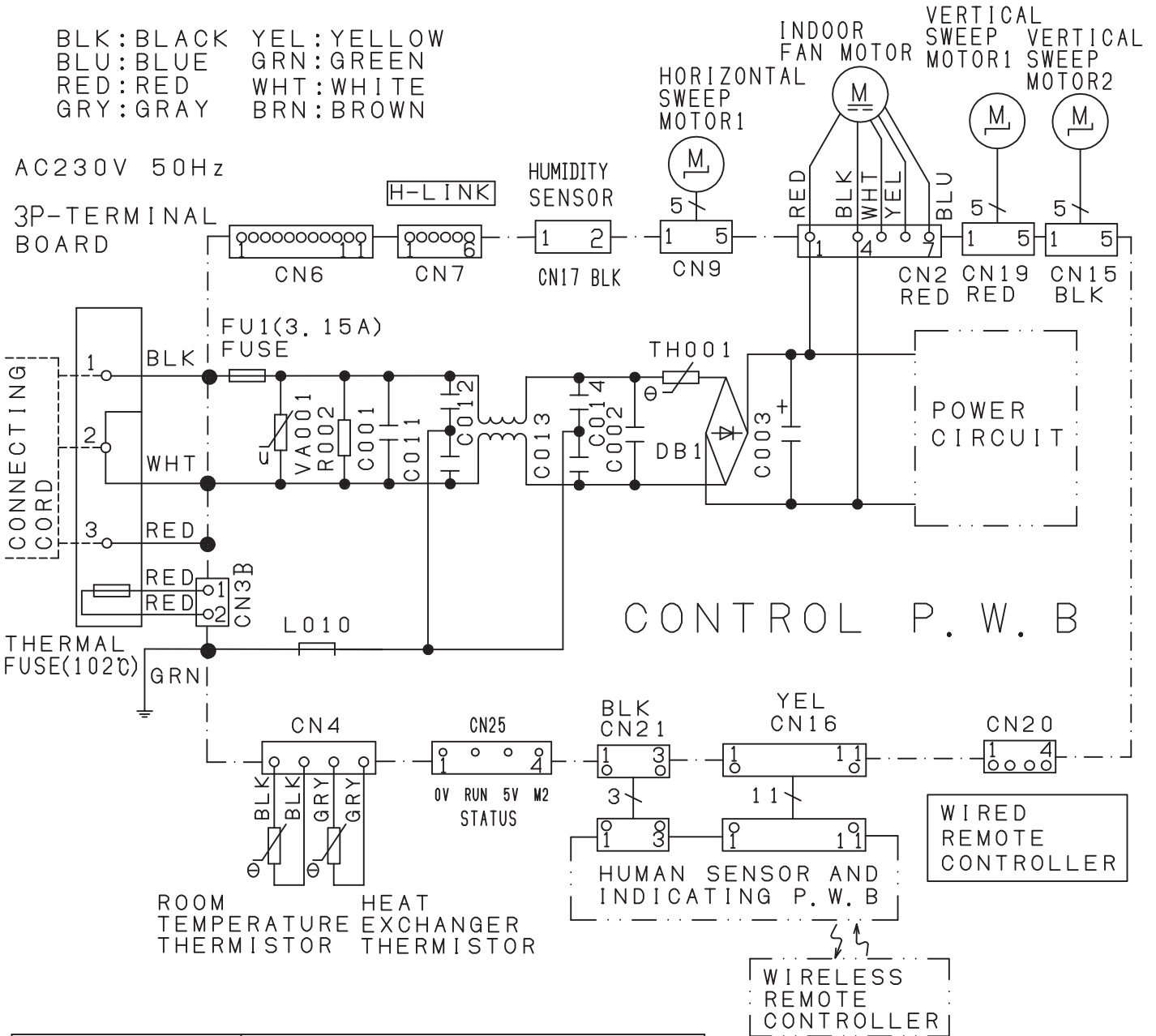

CAUTION! HIGH VOLTAGE    TURN OFF THE POWER SOURCE DURING THE SERVICE WORK.

\* SOME MODELS NOT NEED TO INSTALL THE HUMIDITY SENSOR

7.2. RAC-25WXEN, RAC-35WXEN, RAC-50WXEN

# WIRING DIAGRAM

BLU:BLUE RED:RED BRN:BROWN YEL:YELLOW  
 BLK:BLACK WHT:WHITE GRN:GREEN GRY:GRAY

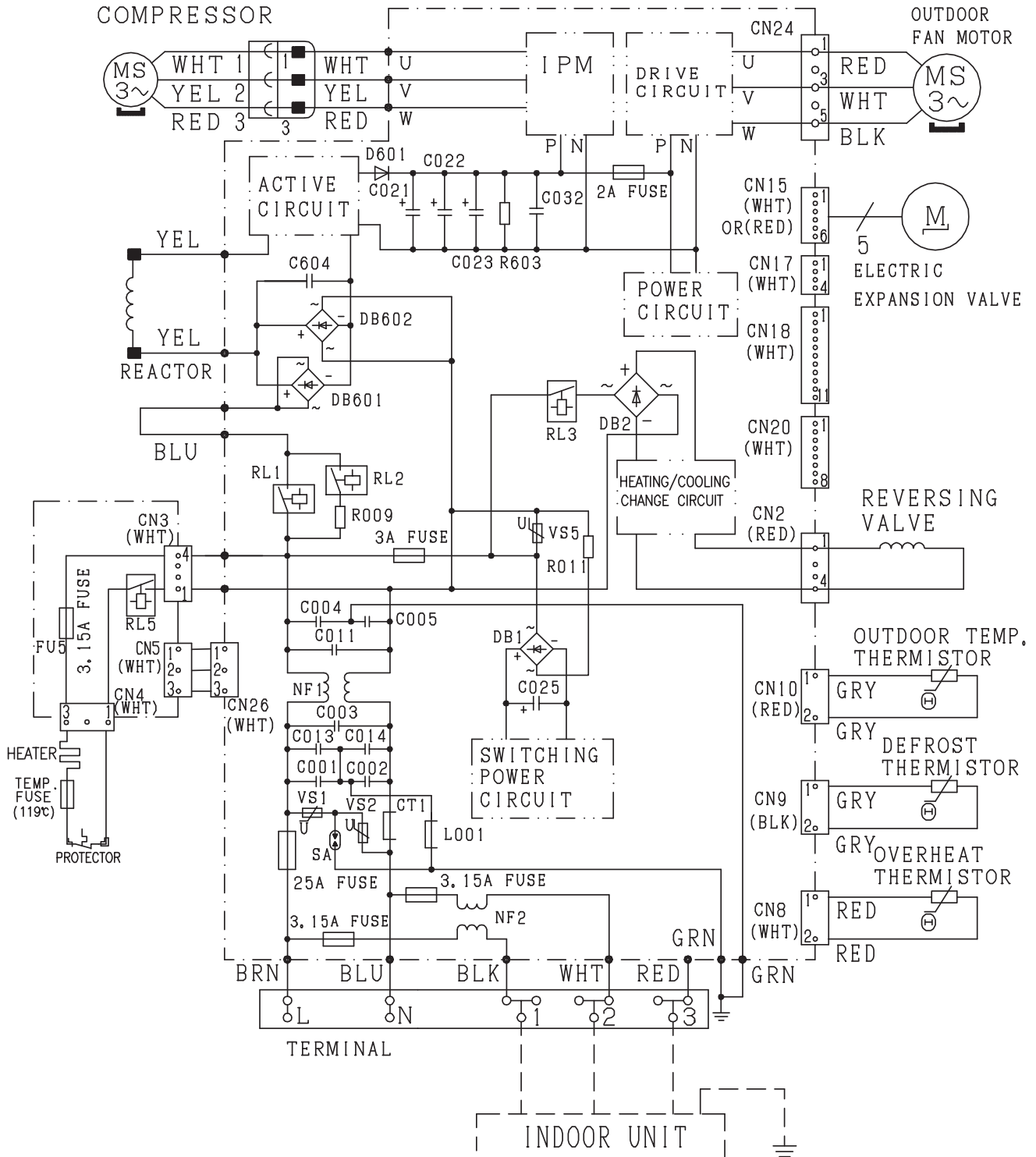

## 8 REFRIGERANT CYCLE

### 8.1. WALL TYPE: RAK-25RXE/RAC-25WXEN, RAK-35RXE/RAC-35WXEN

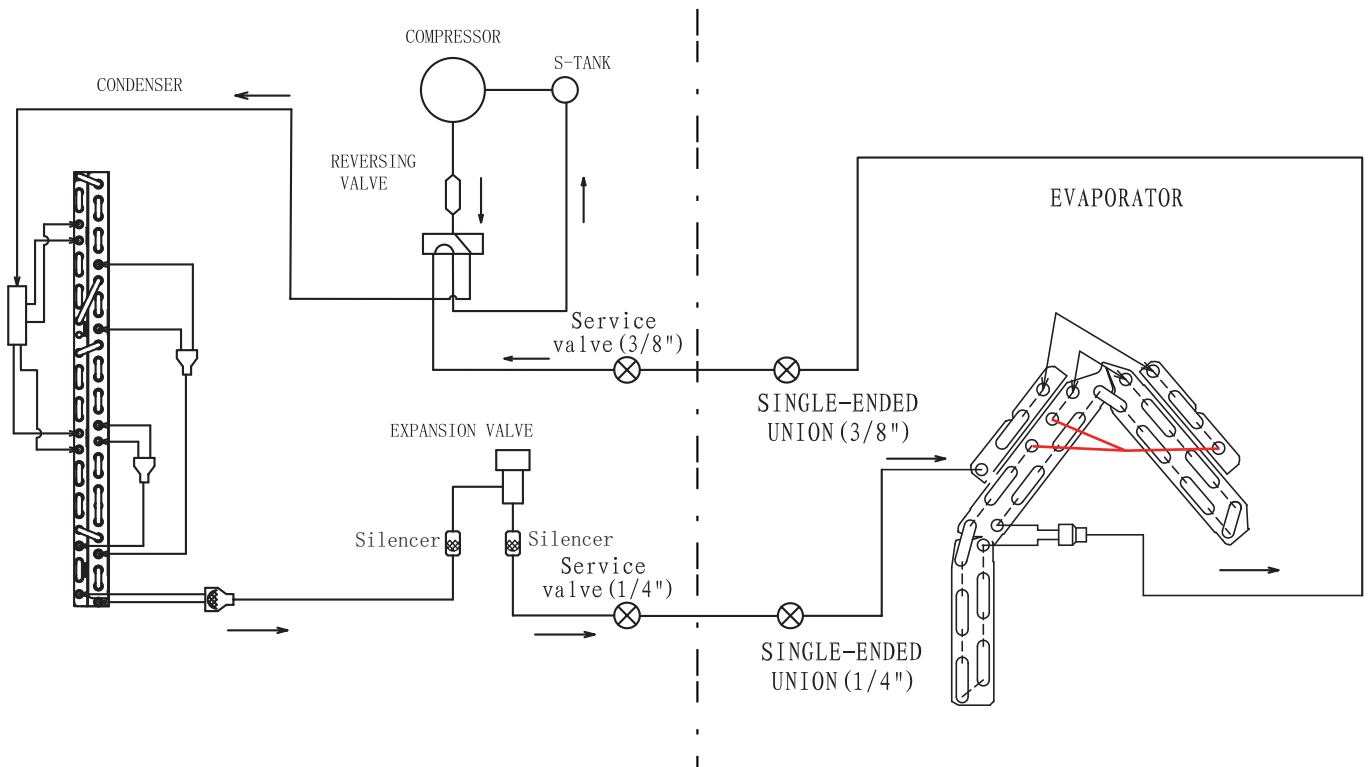

### 8.2. WALL TYPE: RAK-50RXE/ RAC-50WXEN

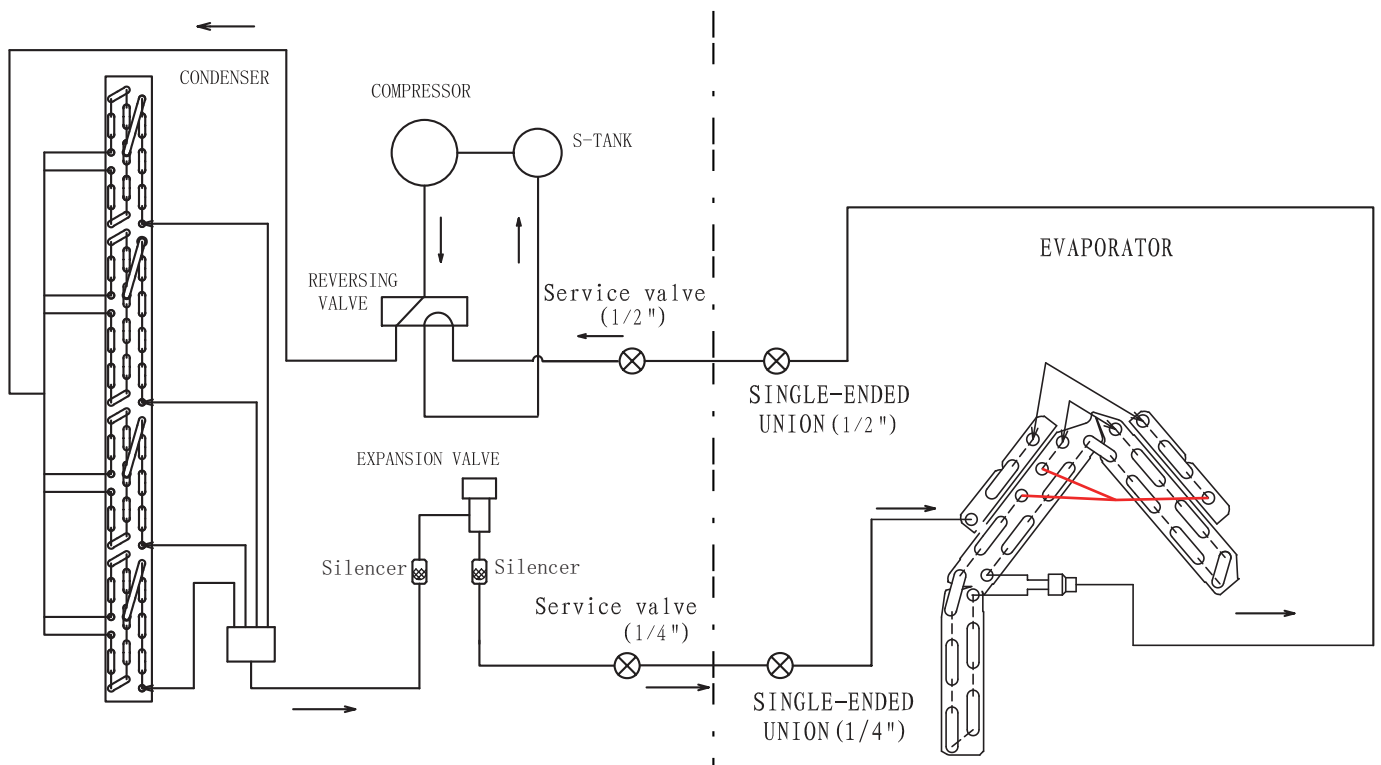

## 9 CONTROL AND FUNCTION

### 9.1. WIRELESS REMOTE CONTROL FUNCTION

BUTTONS	FUNCTION
	<b>MODE Selector</b> Use this button to select the operating mode. Every time you press this button, the mode will change from  (AUTO) →  (HEAT) →  (DEHUMIDIFY) →  (COOL) and →  (FAN) cyclically.
	<b>FAN SPEED Selector Button</b> This determines the fan speed. Every time you press this button, the airflow rate will change from  (AUTO) →  (HIGH) →  (MED) →  (LOW) →  (SILENT) (This button allows selection of optimal or preferred fan speed for each operation mode).
	<b>START/STOP button</b> Press this button to start operation. Press it again to stop operation.
	<b>ECO button</b> Use this button to set the ECO mode.
	<b>POWERFUL button</b> Use this button to set the POWERFUL mode.
	<b>SILENT button</b> Use this button to set the SILENT mode.
	<b>INFO button</b> 1) Press this button to display temperature for 10 seconds. 2) Press this button to check monthly power consumption. 3) Press this button to receive the current calendar and clock.
	<b>ECO SLEEP TIMER button</b> Use this button to set the ECO sleep timer.
	<b>AUTO SWING (Vertical) button</b> Controls the angle of the horizontal air deflector.
	<b>AUTO SWING (Horizontal) button</b> Controls the angle of the vertical air deflector.
	<b>LEAVE HOME button</b> Prevent the room temperature from falling too much by setting temperature 10°C~16°C when no one is at home.
	<b>FROST WASH / CLEAN button</b> The dust and dirt adhering to indoor heat exchanger which is the cause of the smell. They are washed away by freezing and thawing of the heat exchanger.
<b>WEEKLY TIMER buttons</b>	
	<b>ON/OFF TIMER button</b> The device will turn on (off) and off (on) at the designated time.
	<b>TIME button</b> Press the button to set starting time of the program
	<b>OK button</b> Press the button to save the program. The button shall be pressed everytime after finishing a program setting.
	<b>DELETE button</b> 1) Press the button to delete the selected program. 2) Press the button for about 10 seconds by directing the remote controller towards the indoor unit while Mode A or B display blinks, programs for Mode A or B will be deleted both from the indoor unit and the remote controller after the beep sound from the indoor unit.
	<b>DAY button</b> Select the desired day of the week.
	<b>PROGRAM NO. Button</b> Press this button to select a program number.
	<b>CANCEL</b> 1) Press the button to cancel the current setting process on the screen. 2) Press the button by directing the remote controller towards the indoor unit, then weekly timer setting will be canceled from indoor unit after the beep sound from the indoor unit. The program setting remains in the remote controller.
	<b>SEND button</b> Press the button for about 3 seconds by directing the remote controller towards the indoor unit after finishing the program setting. Timer lamp on the indoor unit will blink rapidly and after the beep sound from indoor unit, TIMER lamp will light up.
	<b>CLOCK button</b> Press the button to set calendar and clock.
	<b>WEEKLY TIMER MODE button</b> 1) Select Mode A or Mode B. 2 modes can be set and stored as a weekly timer. 2) By pressing the button longer than 3 seconds, program setting screen will appear.

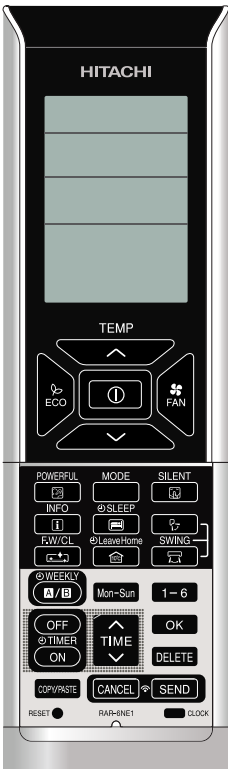

RAR-6NE1

### 9.2. AUTO CHANGEOVER

COOLING/HEATING mode is decided by the room temperature.

- A. COOLING/HEATING mode is decided during the **initial startup** of Automatic Operation  
 Initial startup of Automatic Operation means the following either condition:
- Unit start up in Automatic Operation
  - Automatic Operation mode is pressed while the unit is running in manual mode

Startup room temperature	COOL / HEAT
>= Remote controller setting temperature	Unit runs in COOLING mode
< Remote controller setting temperature	Unit runs in HEATING mode

- B. COOLING/HEATING mode is decided in **intervals after the initial startup** of Automatic Operation (also known as Auto Changeover function)

Intervals	Duration
1 <sup>st</sup> interval	10 minutes
2 <sup>nd</sup> interval	15 minutes
Subsequent interval	Every 55 minutes

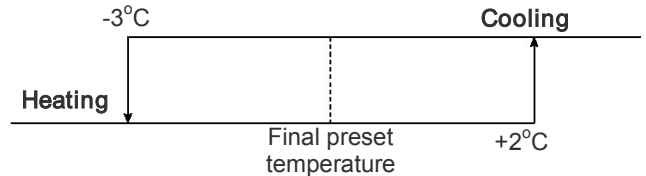

### 9.3. SHIFT VALUE

1. Press and hold (START/STOP) button and (ON) button.
2. Press (RESET) button on the same time. Release (RESET) button only, then release (START/STOP) and (ON) button once Screen 1 appears.

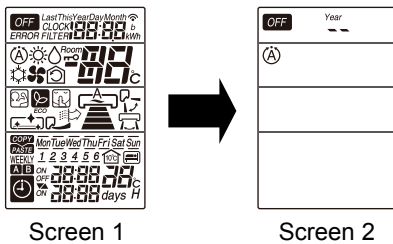

Screen 1

Screen 2

4. Press (START/STOP) and Screen 4 appear.

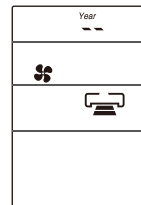

Screen 4

3. Press the (MODE) button to display fan mode (Screen 3).

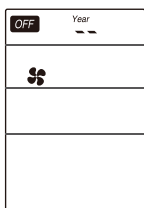

Screen 3

5. Select (FAN SPEED) button to choose Heating Shift or Cooling Shift Mode (Screen 5).

By setting fan speed to HIGH or MED, it will go to Cooling Shift mode.  
 By setting fan speed to LOW or SILENT, it will go to Heating Shift mode.

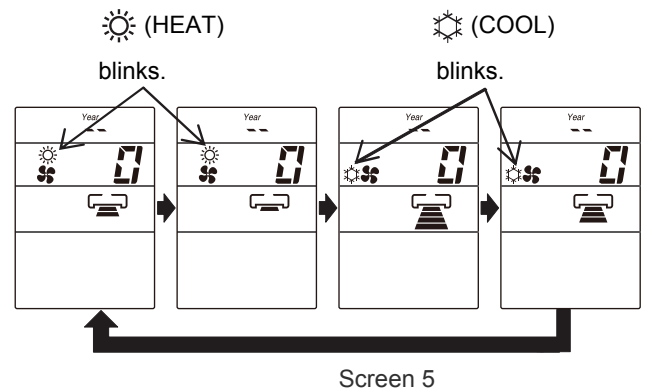

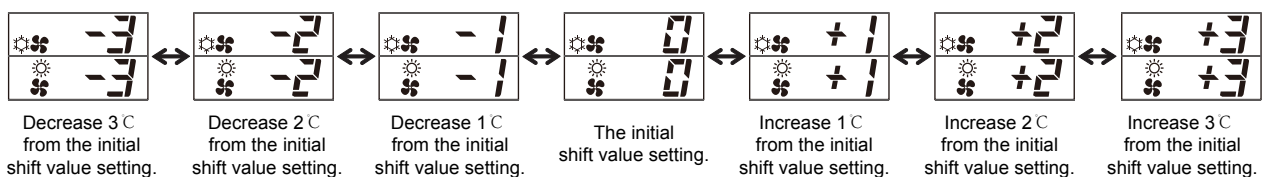

Screen 5

6. Press the Temperature button (V or ^) to adjust the shift value.









NOTE:

1. There are total of 7 shift values ranging from -3 to 3.
2. The displayed shift value,  (HEAT) and  (COOL) symbol on the remote controller display will be disappear after 10 seconds
3. The changed shift value will remain unchanged after turned off the power.
4. If “0” is displayed on the remote controller display, it indicates the shift value is now at the initial setting.

### 9.4. OPERATION LOCK

1. HEATING MODE

- a) Press and hold  (ECO) and  (POWERFUL) buttons, press  (RESET) button on the same time. Release  (RESET) button only when Screen 1 appear, then release  (ECO) button and  (POWERFUL) button.

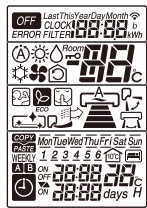

Screen 1



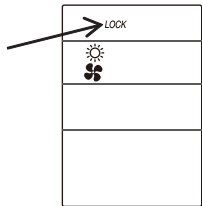

- b) Wait until only Screen 2 appear.





Screen 2

- c) The heating mode operation is locked.
- d) To unlock HEATING mode, repeat step (a). After all operations mode symbols displayed for 10 seconds, the operation mode symbol before cancellation will be display. The heating mode operation is unlocked.

2. COOLING AND DEHUMIDIFYING MODE

- a) Press and hold  (ECO) and  (SILENT) buttons for at least 5 seconds when the remote controller is OFF.
- b) Wait until only  and  displayed on the screen. The cooling and dehumidifying modes operation is locked.
- c) To unlock HEATING mode, repeat step (a). After all operations mode symbols displayed for 10 seconds, the operation mode symbol before cancellation will be display. The cooling and dehumidifying mode operation is unlocked.

### 9.5. SETTING THE PREVENTION OF MUTUAL INTERFERENCE

1. Please ensure the other indoor unit is OFF.
2. Press  (PROGRAM NO.) button,  (ON TIMER) button and  (RESET) button simultaneously. The remote controller will display Screen 1 and followed by Screen 2. The indoor unit beeps to indicate that it has just received the signal from remote controller.

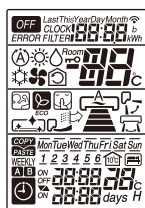

Screen 1

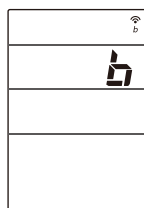

Screen 2

NOTE:







1. If indoor unit still not receive the correct signal from the correct remote controller, setting shall be made again. By setting again for the 2nd time, the signal address will change from B to A, then repeat again for the 3rd time.



## 9.6. INTERMITTENT FAN SPEED SETTING

The intermittent fan control during thermo off in Heating Mode can be changed by the remote controller.  
(This procedure should be done only by service personnel.)  
It is possible to select from 3 patterns.

### PROCEDURE

- Press  [START/STOP] button,  [Mon-Sun] button and press  [RESET] button simultaneously. Release  [RESET] button only and make sure that all marks on the remote controller display are indicated, then release  [START/STOP] button and  [Mon-Sun] button. Remote controller now enters "Intermittent Fan Control Change Mode".

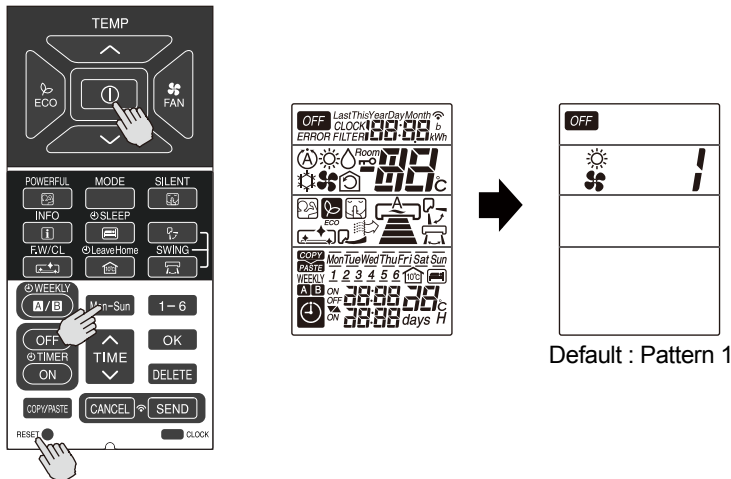

- Press [ROOM TEMPERATURE setting] [ $\wedge$ (UP)]/[ $\vee$ (DOWN)] buttons.  
(The intermittent pattern changed with indoor unit beep sound.)

Transmission sign lights up with beep from indoor unit simultaneously.

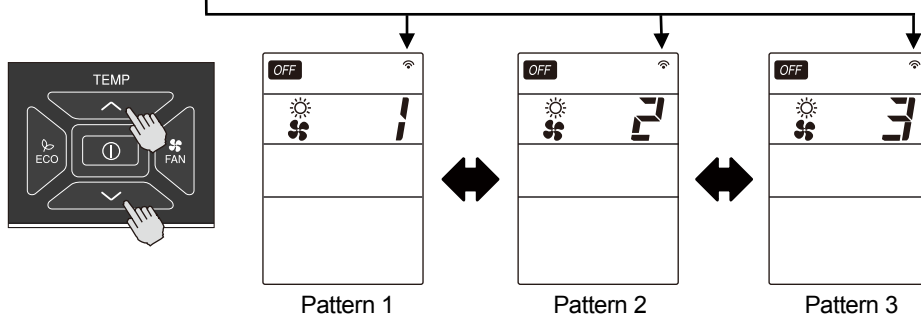

	Pattern 1	Pattern 2	Pattern 3
Single Model	Continuous	30sec ON / 210sec OFF repeatedly	50sec ON / 190sec OFF repeatedly
Multi Model	30sec ON / 210sec OFF repeatedly	50sec ON / 190sec OFF repeatedly	Continuous



#### NOTE :

- The indication of the selected intermittent pattern will disappear after 10 seconds.
- The selected intermittent pattern will remain unchanged after the unit is turned off.

### 9.7. FAN SPEED SETTING IN THERMO OFF IN COOLING

The fan speed in Cooling Mode during thermo off can be changed by the remote controller.  
 (This procedure shall be implemented strictly by service personnel only.)  
 It is possible to return it to the default setting.

#### PROCEDURE

Press  [POWERFUL] button and  [TIME ^ (UP)] button simultaneously for about 5 seconds when the remote controller is OFF.

Transmission sign lights up with beep from indoor unit simultaneously.

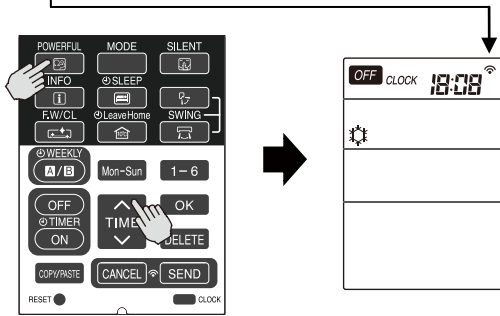



- Beep sound pattern :
- 1) Default setting : Short beep
  - 2) Changed setting : Double beep

	Fan speed during thermo off
Default Setting	Ultra low
Changed Setting	Set fan speed (When auto fan speed is set, the fan speed is low)

**NOTE :**

- (1) The selected fan speed will remain unchanged after the unit is turned off.
- (2) If Timer reservation has been set, it will be canceled.
- (3) During time setting and timer setting, this operation cannot be set.

## 9.8. ERROR CODE INFORMATION

1. In case failure occurs to the air conditioner, by pressing  (INFO) button, an error code will be displayed.
2. Direct the remote controller towards the receiver of indoor unit (within 2 meters in from of indoor unit) and press  (INFO) button.
3. Wait for 2 seconds for signal transmission and the error code will be displayed.

	TIMER LAMP BLINKING	LED301 BLINKING	CODE	MEANING
INDOOR	-	-	000 00	Normal
	1 time	-	001 00	Refrigerant cycle fault
	2 times	-	-	Outdoor unit is under forced operation
	3 times	9 times	003 00	Communication error between indoor and outdoor units
	9 times	-	009 00	Indoor thermistor
	10 times	-	010 00	Abnormal rotating numbers
	12 times	-	012 00	Communication error between indoor and outdoor units
	13 times	-	013 00	IC401 data reading error
OUTDOOR	4 times	2 times	002 01	Peak current cut
	4 times	3 times	003 01	Compressor abnormal low speed rotation
	4 times	4 times	004 01	Compressor switching failure
	4 times	5 times	005 01	Overload lower limit cut
	4 times	6 times	006 01	OH thermistor temperature rise
	4 times	7 times	007 01	Abnormal outdoor thermistor
	4 times	9 times	009 01	Communication error
	4 times	10 times	010 01	Abnormal power source
	4 times	11 times	011 01	Fan stop for strong wind
	4 times	12 times	012 01	Fan motor fault
	4 times	13 times	013 01	EEPROM reading error
	4 times	14 times	014 01	Active converter defective
	4 times	15 times	015 01	Abnormal PWB circuit
4 times	16 times	016 01	High load stop	

### 9.9. ADDITIONAL FUNCTION VIA DIP-SWITCH SETTINGS

A new DIP Switch is available on the PWBs of the indoor unit that provide additional functions via the settings on the switches.

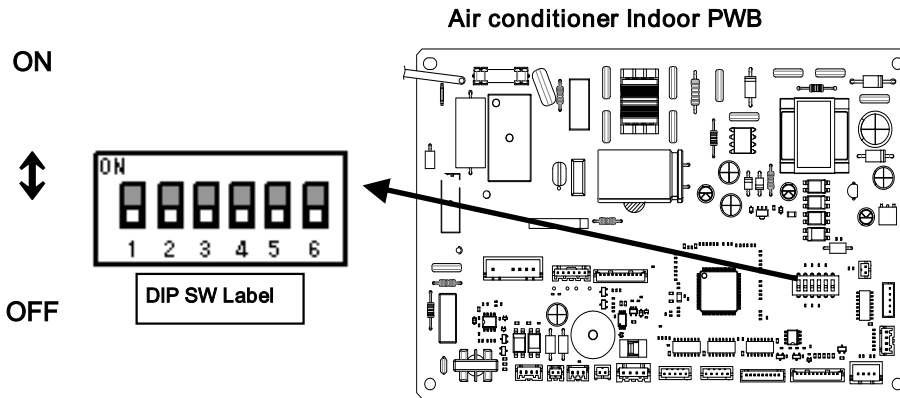

SW No.	I T E M		F U N C T I O N				
1	AUTO RESTART	OFF*	ENABLE	ON	DISABLE		
2	CARD KEY MODE	OFF*	DISABLE	ON	ENABLE		
3	CARD KEY LOGIC SELECT	OFF*	INPUT HIGH ACTIVE	ON	INPUT LOW ACTIVE		
4	HEATING/COOLING ONLY MODE SELECT	OFF*	HEATING & COOLING	OFF	HEATING ONLY	ON	HEATING & COOLING
5	HEATING/COOLING ONLY MODE SELECT	OFF*		ON		OFF	
6	REMOCON ID SELECT	OFF*	SELECT ID : A	ON	SELECT ID : B		

NOTE:

\* Marking is position of shipping [FACTORY default setting]

#### 9.9.1. AUTO RESTART FUNCTION

The AUTO RESTART function can be enabled or disabled by setting Pin No. 1 on the DIP SWITCH above to the ON or OFF position accordingly.

#### 9.9.2. HEATING/COOLING ONLY MODEL SELECTION

When this function is enabled, the operation mode could be locked to either Heating Only (Heating or Fan) or Cooling Only (Cooling, Fan or Dehumidifying) by setting the Pin No. 4 and 5 accordingly.

LOCKED MODE	REMARKS
HEATING ONLY	Unit will not enter into Cooling mode although cooling mode is selected using the remote controller.
COOLING ONLY	Unit will not enter into Heating mode although heating mode is selected using the remote controller.

## 10 OPTION LIST

### 10.1. WIRED REMOTE CONTROL – SPX-RCDB

 <p>RAR-5G2 (SPX-RCDB)</p>	BUTTONS	FUNCTION
		<b>MODE Selector</b> Use this button to select the operating mode. Every time you press this button, the mode will change from  (AUTO) →  (HEAT) →  (DEHUMIDIFY) →  (COOL) and →  (FAN) cyclically.
		<b>FAN SPEED Selector Button</b> This determines the fan speed. Every time you press this button, the airflow rate will change from  (AUTO) →  (HIGH) →  (MED) →  (LOW) →  (SILENT) (This button allows selection of optimal or preferred fan speed for each operation mode).
		<b>ON/OFF button</b> Press this button to start operation. Press it again to stop operation.
		<b>SLEEP button</b> Use this button to set the SLEEP timer.
		<b>SET button</b> Timer setting reservation.
		<b>OFF button</b> Select the turn OFF timer.
		<b>ON button</b> Select the turn ON timer.
		<b>CANCEL button</b> Cancel timer reservation.
		<b>AUTO SWING (Vertical) button</b> Controls the angle of the horizontal air deflector.
	<b>ROOM TEMPERATURE setting button</b> Value will change quicke when keep pressing.	

#### 10.1.1. SHIFT VALUE

1. Press and hold (ON/OFF) button and (ON TIMER) button at the same time while giving a single press on the RESET button until remote controller now enter 'Shift value change mode'.
2. Press (ON/OFF) button so that the display indicates (FAN) speed.
3. Select (FAN SPEED) button to choose Heating Shift or Cooling Shift Mode.

By setting fan speed to HIGH or MED , it will go to Cooling Shift mode.

By setting fan speed to LOW or SILENT , it will go to Heating Shift mode.





4. Press (ROOM TEMPERATURE) button to change the shift value (-3°C ~ 0 ~ 3°C).
5. Press (ON/OFF) button to end 'Shift value setting mode'.

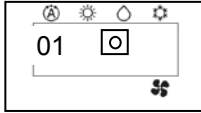

#### NOTE:

1. There are total of 7 shift values ranging from -3 to 3.
2. The changed shift value will remain unchanged after turned off the power.

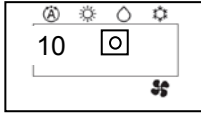
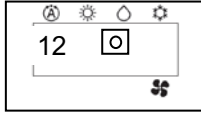
## 10.1.2. ERROR CODE INFORMATION

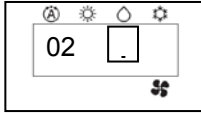
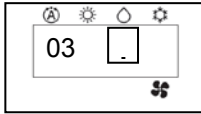
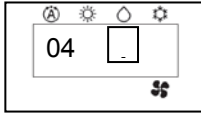
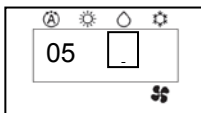
1. In case failure occurs to the air conditioner, the error code will constantly appear on the wired remote controller display.

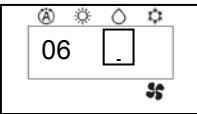
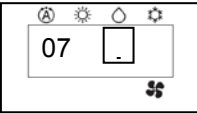
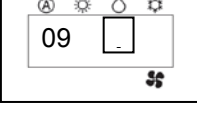
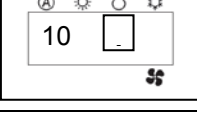
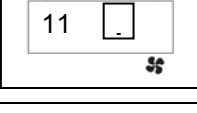
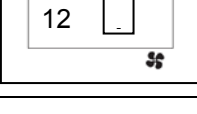
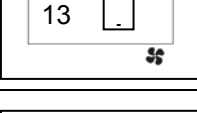
	TIMER LAMP BLINKING	LD301 BLINKING	CODE	MEANING
INDOOR	-	-	-	Normal
	1 time	-		Refrigerant cycle fault
	2 times	-	-	Outdoor unit is under forced operation
	3 times	9 times		Communication error between indoor and outdoor units
	9 times	-		Indoor thermistor
	10 times	-		Abnormal rotating numbers
	12 times	-		Communication error between indoor and outdoor units
	13 times	-		IC401 data reading error
OUTDOOR	4 times	2 times		Peak current cut
	4 times	3 times		Compressor abnormal low speed rotation
	4 times	4 times		Compressor switching failure
	4 times	5 times		Overload lower limit cut

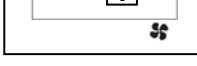
	TIMER LAMP BLINKING	LD301 BLINKING	CODE	MEANING
OUTDOOR	4 times	6 times		OH thermistor temperature rise
	4 times	7 times		Abnormal outdoor thermistor
	4 times	9 times		Communication error
	4 times	10 times		Abnormal power source
	4 times	11 times		Fan stop for strong wind
	4 times	12 times		Fan motor fault
	4 times	13 times		EEPROM reading error
	4 times	14 times		Active converter defective
	4 times	15 times		Abnormal PWB circuit
	4 times	16 times		High load stop

## 10.2. H-LINK ADAPTOR – PSC 6RAD

### 10.2.1. SAFETY SUMMARY

**DANGER:**

- DO NOT pour water into the remote control switch (hereafter called “controller”). This product is equipped with electrical parts. This will cause serious electrical shock.

**WARNING:**

- DO NOT perform installation work and electrical wiring connection by yourself. Contact your distributor or dealer of HITACHI and ask then for installation work and electrical wiring by service person. The specified cable should be used to connect (i) room air conditioner and adaptor, and (ii) controller and adaptor.



**CAUTION:**



- DO NOT install the indoor unit, outdoor unit, controller and cable as such places as:
  - where there is oil vapor and dispersion of oil
  - where there is sulfuric environment (near the hot springs)
  - where there is a flammable gas
  - where there is salty environment (near the sea)
- DO NOT install the indoor unit, outdoor unit, controller and cable within approximately 3 meters from strong electromagnetic wave radiators, such as medical equipment. In case that the controller is installed in a place where there is electromagnetic wave direct-radiation, shield the controller and cables by covering with the steel box and running the cable through the metal conduit tube.
- In case that there is electric noise at the power source for the indoor unit, provide a noise filter.

### 10.2.2. INSTALLATION WORK

■ Before installation

Check the contents and the number of the accessories in the packing.

Adaptor	 <p>With two 1.8m cables</p>
1 piece of cover for hiding the covering	 <p>Attached 2 sided tapes</p>
Two-sided tape for attaching to Adaptor	 <p>110x40x3mm</p>

2 connectors for H-Link connection		
2 tapping screws for attaching to wall		φ3.0 x 10mm
2 screws for attaching to wooden wall		φ3.1 x 16mm

- 1) RAC adaptor can be installed to the wall as well as on the air conditioner itself
- 2) Install RAC adaptor in the vertical surface as shown below.

Upper side

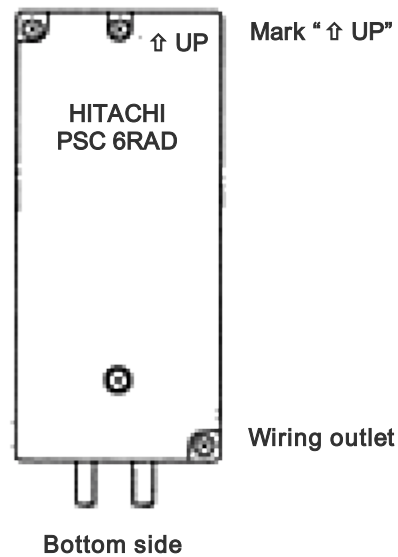

- 3) Installation procedure
  - a) When installing to the wall.
    - i) Fix the adaptor with 2 screws. Tapping screw is for metal surface, and other screw is for wooden surface.

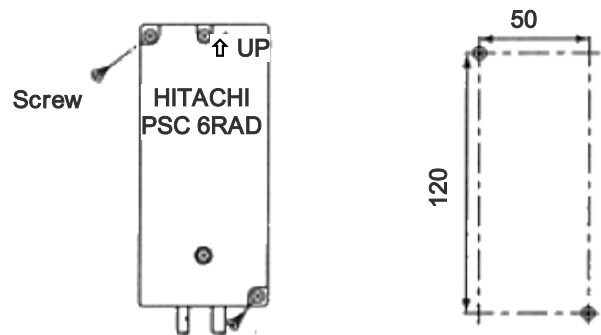

- ii) When using the cover
  - i) It can be installed at the right and left side of room air conditioner. Fix the cover and RAC adaptor with the two-sided tape (accessory).



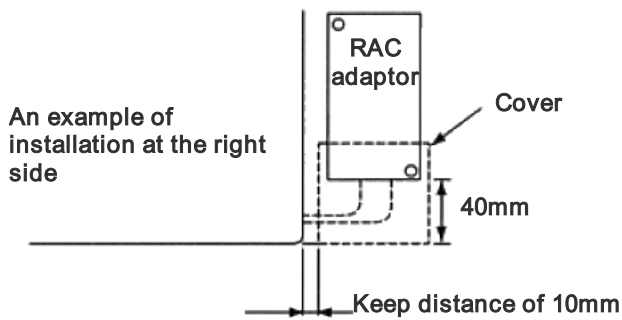

- b) When installing on the room air-conditioner
- In case that it cannot be installed to the wall due to the space or material problem, install the RAC adaptor with the two-sided tape (accessory) on the room air-conditioner.
- Confirm if the piping cover of the unit can be removed when performing the service maintenance, and then fix the RAC adaptor in the side of room air-conditioner with two-sided tape. (Available at the right as well as left side)
  - Clean the surface to be installed with a dry cloth.

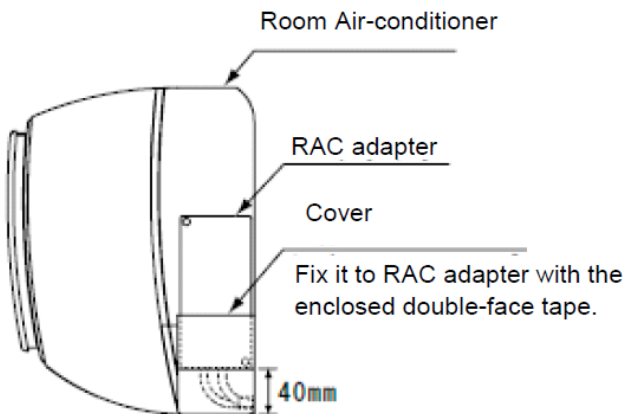

**NOTE:**

- Consider the following points since the adhesiveness changes according to the environmental conditions (temperature, humidity etc)
- The adhesiveness is decreased when there is humidity or oil.
- Warm the adhesive part and installation place of the two-sided tape to avoid the decrease of the adhesiveness in case the ambient temperature is low.
- DO NOT touch the adhesive part by fingers nor re-attach it many times. The adhesiveness has decreased and the RAC adaptor may fall off.
- DO NOT apply any force within 24 hours after installation.

**10.2.3. ELECTRICAL WIRING**

■ System configuration

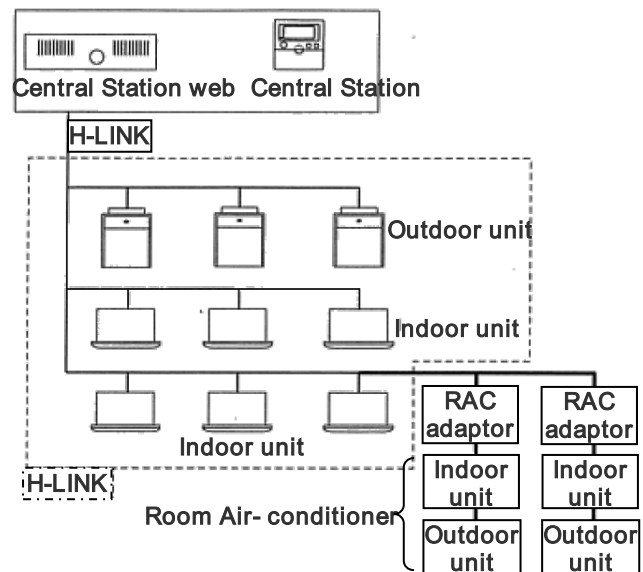

**CAUTION:**

- Turn OFF the power supply of the room air-conditioner of the central control device when performing the wiring work
- DO NOT run all the H-LINK cable or power supply cable along the other signal cable, or malfunction may occur due to the noise, etc. If it is required to run along the other transmission cable, separate the cable more than 30cm, or run the cable through the metal tube and earth the tube.
- Follow local codes and regulations when performing electrical wiring and earth wiring.
- Transmissions cable used in H-LINK shall be 2 cores cable (0.7mm<sup>2</sup> to 1.25mm<sup>2</sup> for model: VCTF, VCT, CVV, MVVX, CVVX, VVR, VVF) or 2 cores twisted pair cable (model: KPEV, KPEV-Spec). Total length of cable shall be below 1000mm.
- DO NOT use wire with more than 3 cores.

■ Internal components and Wiring connections

Check the contents and the number of the accessories in the packing.

- Access  
Open the cover by removing the ① and ② screws.



- Wiring Connection  
Connection with Room Air-Conditioner

  - Remove the front cover of the room air-conditioner and the cover of electrical box.
  - The cable attached with the connector of the RAC adaptor shall be connected with the connector of indoor PCB

- iii) Install the electrical box cover paying attention not to clamp the cable. Read the installation manual of each room air-conditioner for confirming how to connect and how to assemble the cable of the RAC adaptor.

**CAUTION:**

- Disconnect the power plug before performing this work
- Turn OFF the break power source in case the power is supplied from the outdoor unit.

- Connection of Transmission Cable

H-LINK transmission cable connecting to RAC adaptor shall be connected to H-LINK.

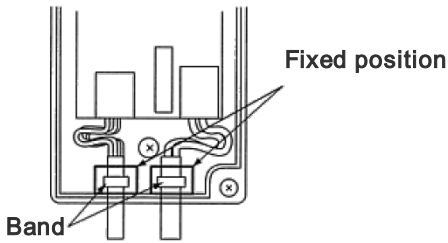
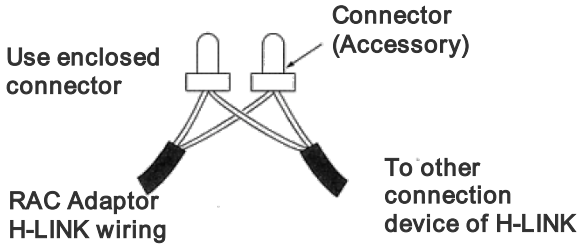

**CAUTION:**

- DO NOT connect incorrect wiring. It may cause the failure of the RAC Adaptor. Especially pay attention not to apply high voltage e.g. AC400/230V.
- DO NOT perform the wiring work while power to the central station or the RAC Adaptor is still being supplied. It may cause malfunction. Turn OFF devices when performing the wiring work.
- The RAC Adaptor side cable should not overload to the connector.
- DO NOT clamp the cable when attaching the RAC adaptor cover.
- Band should not be loose and in fixed position.

**10.2.4. DIP SWITCH SETTING**

- 1) Switch OFF the power of room air conditioner before setting the DIP switch. If the power is ON, the settings are INVALID.
- 2) The position of the DIP switch is shown below.

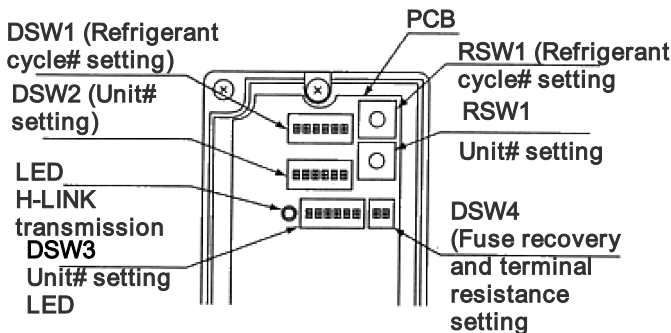

**CAUTION:**

- DO NOT turn ON various pins of DSW1 and DSW2

- 3) Set the refrigerant cycle# by RSW1 and DSW1

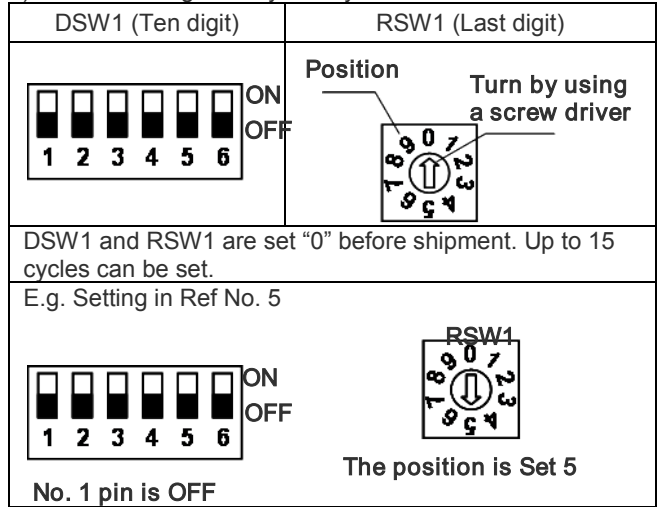

- 4) Set the unit No. by RSW2 and DSW2

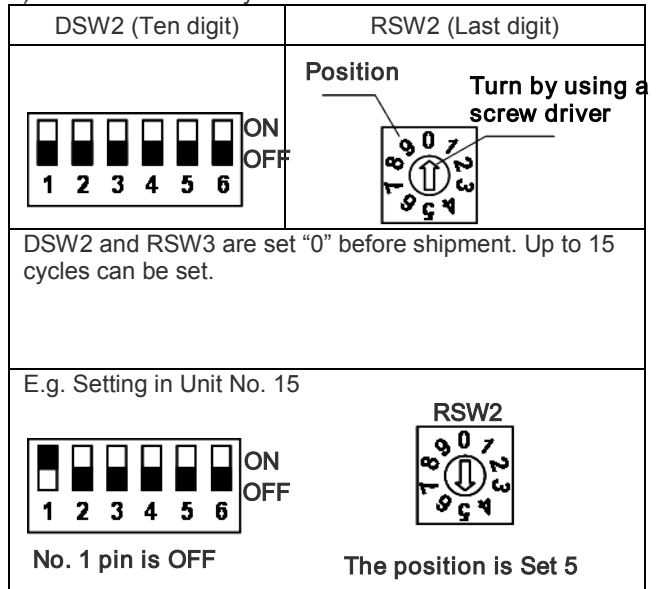

- 5) Slave unit.

In case of setting various RAC adaptors in the same refrigerant cycle, set the RAC adaptor with smallest Unit# as a master unit. In case of setting only one RAC adaptor in a refrigerant system, this adaptor should be a master unit. Set this procedure by DSW3.

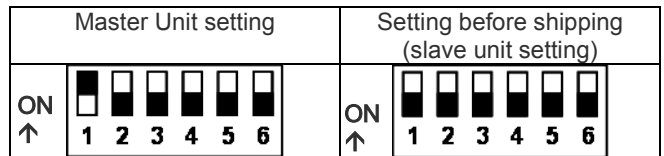

●: Master Unit setting

○: Setting before Shipping (Slave Unit setting)

		Indoor Unit#							
		0	1	2	3	4	5	6	7
Refrigerant Unit#	0	●	○	○	○	○			
	1			●	○	○			
	2				●	○	○	○	○
	3		●						
	4								

**CAUTION:**

– DO NOT set various main adaptors in the same refrigerant cycle.

- 6) Procedure when applying 200V voltage to H-LINK wiring incorrectly.

In case of applying 200V voltage to H-LINK wiring incorrectly, the fuse installed in a transmission circuit on PCB will blow out. In this case, reconnect the wiring correctly and turn ON No. 2 pin of DSW4 on PCB. The transmission circuit can be recovered. (If applying this error again, the transmission circuit can not be recovered)

**PCB**



Turn ON No.2 pin of DSW4

- 7) Terminating resistance is set in whole H-LINK system.
  - a) If H-LINK connecting devices like package air-conditioner are connected besides the RAC Adaptor, set the terminating resistance by those connecting devices. The terminating resistance should be set ON in only one position in whole H-LINK system.
  - b) In case that H-LINK is connected only by the RAC adaptor, set the terminating resistance by the RAC adaptor. The terminating resistance should be set ON in only one position in whole H-LINK system.

**PCB**

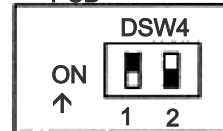

Turn ON No.1 pin of DSW4

**10.2.5. TEST RUN**

Test run should be performed in the following after finishing the installation, wiring and setting. Refer to the installation manuals enclosed with the control system equipment.

- 1) Confirmation of RAC Adaptor Connection
 

Confirm if the RAC adaptor connection is recognized in the control system equipments. In case that it is not confirmed, check the transmission cable, refrigerant cycle #, indoor unit #, terminal resistance setting etc.
- 2) Registration
 

Confirm if the RAC adaptor connection is recognized.
- 3) Confirmation of RUN/STOP Operation.
 

Confirm if the room air-conditioner operate correctly by RUN/STOP from the central control system equipments. Check also if the room air-conditioner operation changes correctly by each setting.

### 10.3. DRY CONTACT (SPX-WDC3) APPLICATION (USING DIP SWITCH)

The dry contact system enables the operation of the air conditioner indoor unit to be controlled by using external dry contacts (with non voltage) such as card-key controller or window for facilities such as hotels.

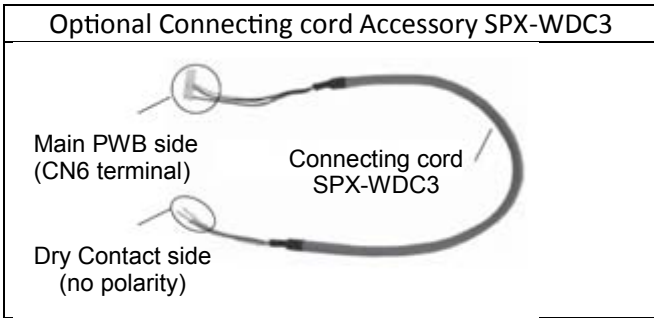

Note:

- 1) AUTO RESTART function set to "Enable" is needed (set pin#1 on the DIP SWITCH SW501 above to OFF position).
- 2) DRY CONTACT function is "Enable" by set pin No. 2 of the DIP SWITCH (DSW1) to ON position.
- 3) Select the proper setting for DRY CONTACT LOGIC INPUT pin No. 3 on DIP SWITCH (DSW1)
  - i) Set to OFF position (Hi Input) if the type of Dry Contact switch to be used (for the CARD KEY UNIT or Window) is of contact type a (Normally Open Type) as shown in below diagram.
  - ii) Set to ON position (Lo Input) if the type of Dry contact switch to be used (for the CARD KEY UNIT or Window) is of contact type b (Normally Close Type) as shown in below diagram.

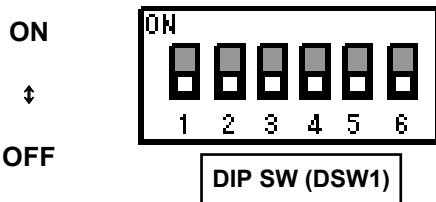

Pin No.	Function	Switch Position / Setting			
2	DRY CONTACT function	OFF	Disable	ON	Enable
3	DRY CONTACT Input Logic	OFF	HI Input Active	ON	LO Input Active

- Please decide the type of dry contact you will be using and set the position of the DIP Switch No. 2 and 3 accordingly

[1] CHECK DRY CONTACT OF CARD KEY UNIT

	AIR CONDITIONER Standby	AIR CONDITIONER Operating
CARD KEY (Door Switch)	REMOVE 	INSERT 
Contact type a	OPEN 	CLOSE 
Contact type b	CLOSE 	OPEN 

[2] SET THE POSITION OF DIP SWITCH

POSITION CONDITION OF DIP SWITCH	
INITIAL CONDITION (CARD KEY NO USE) No.2 : OFF No.3 : OFF	
HI Input Active No.2 : ON No.3 : OFF	
LO Input Active No.2 : ON No.3 : ON	

After all connection has been done as below diagram, ON the breaker and push ON button of wireless remote controller or wired remote controller to operate the air conditioner unit.

- When the CARD KEY is in insert condition, the air conditioner operation is allowable by remote controller.
- When the dry contact switch on the Card Key Unit is open (refer to diagram below for contact type a), the unit stops to operate (it takes 10 seconds to stop the unit operation after the dry contact switch on the card key turns off) and vice versa.
- When the card key is removed from the Card Key Unit, the wireless remote controller cannot be used.
- When the card key is removed from the Card Key Unit, the wired remote controller LCD display is activated; however it has no control over the unit.
- The suitable accessory Connecting Cord (accessory code#: SPX-WDC3) need to be used to connect the Card Key Unit's dry contact switch to the connector on the control board of the indoor unit. Please refer to Table 1 to select suitable accessory code# for the concerning indoor model.

Example of wiring connection to Card Key Unit will be as below (reference only)

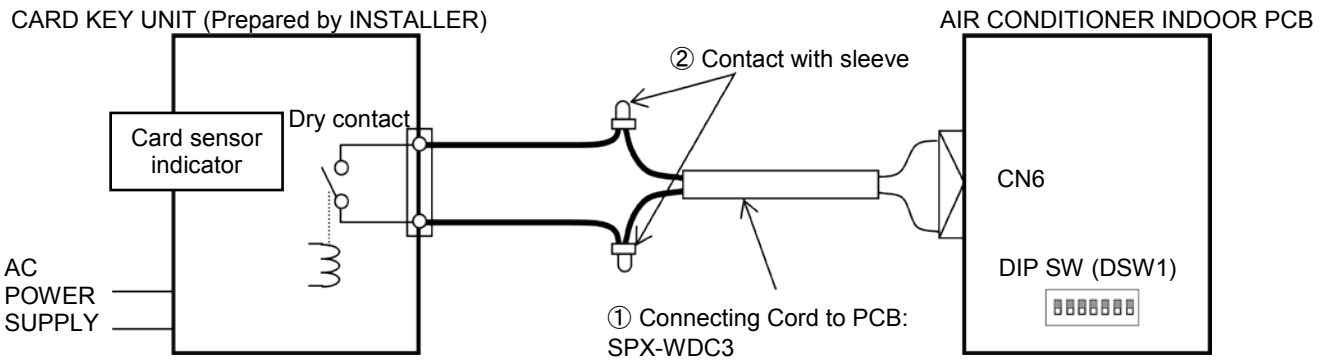

• CONNECTION EXAMPLE

i. Pin No. 3 of DIP SWITCH is set to OFF position (HI Input Active) for Dry Contact Type a

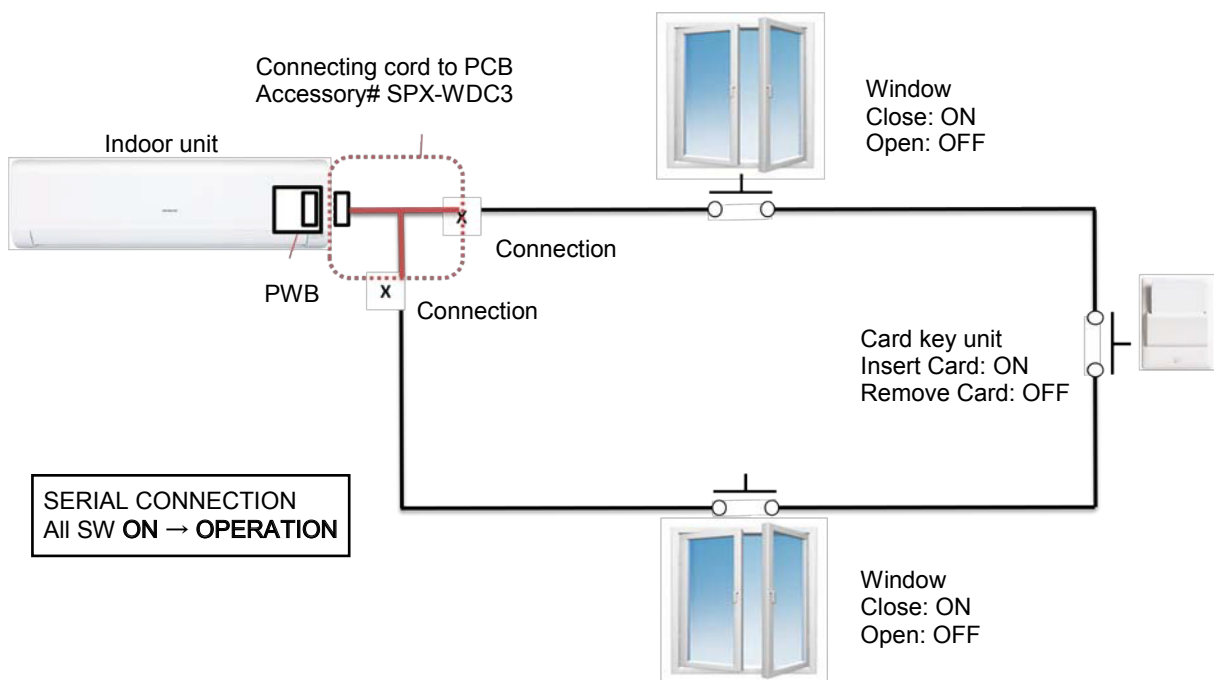

ii. Pin No. 3 of DIP SWITCH is set to ON position (LO Input Active) for Dry Contact Type b

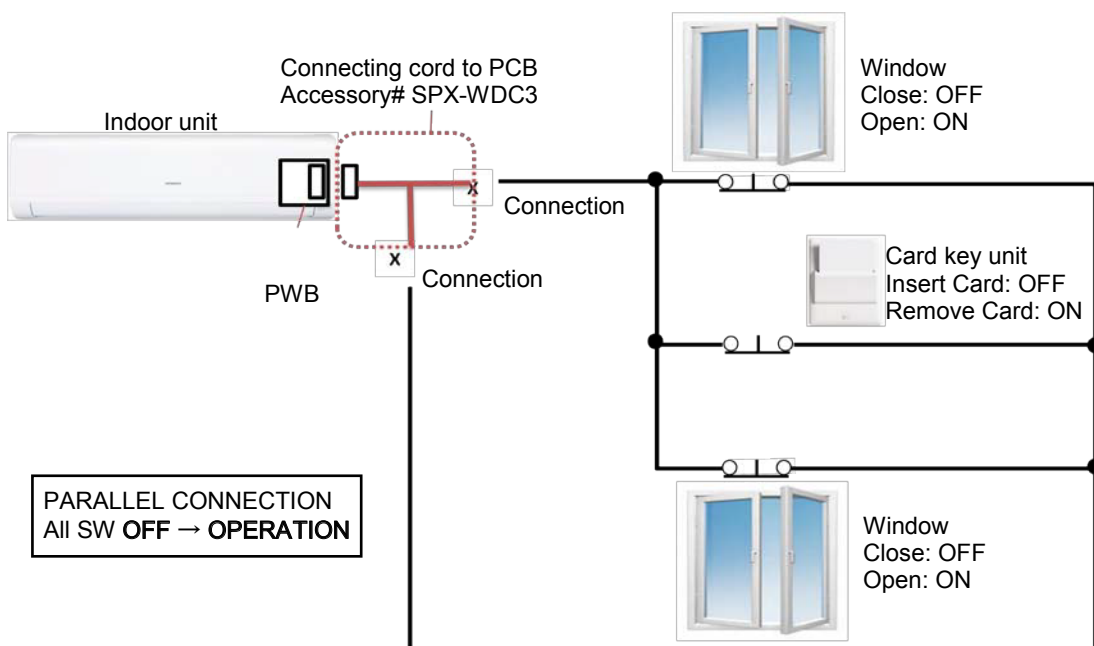

Please refer to the actual manual supplied with the optional connecting cords SPX-WDC3 for more details.

### 10.4. DISTRIBUTOR – SPX-DST1

The optional distributor is to be used together with the wired remote controller when there is a need to centralize the control of multiple indoor units using only a single wired remote controller.

A single distributor could be connected further to 3 separate distributors so that up to 13 units of indoor could be controlled by a single wired remote controller.

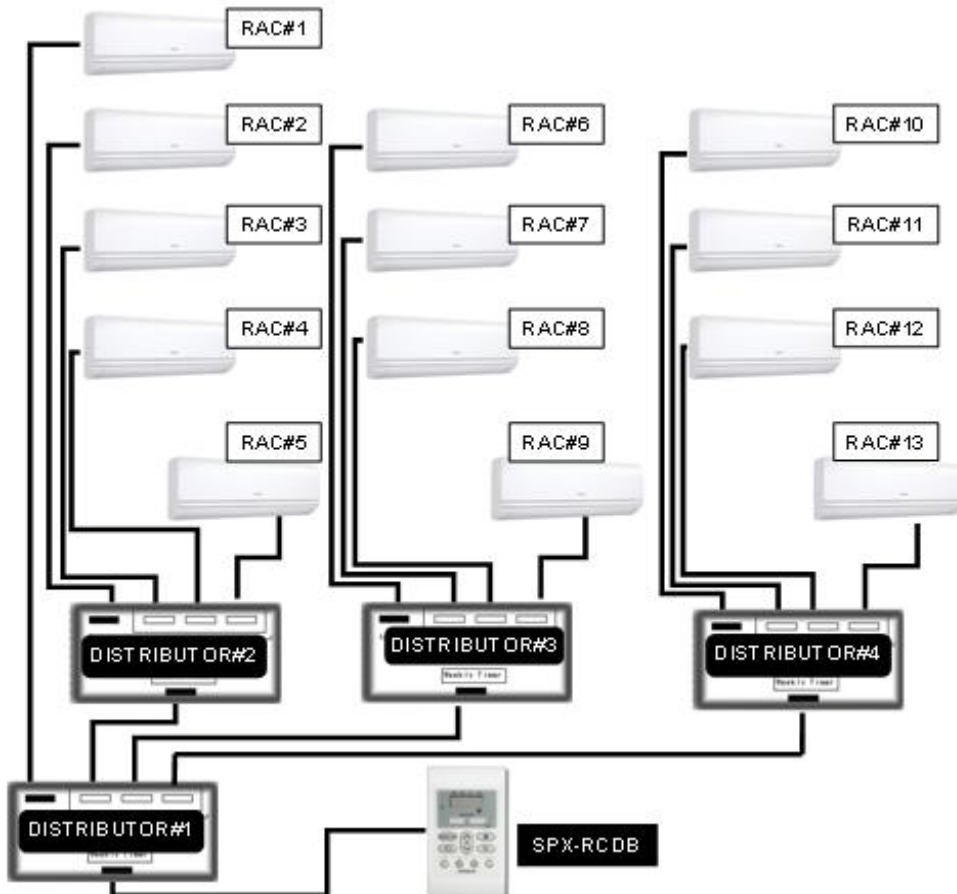
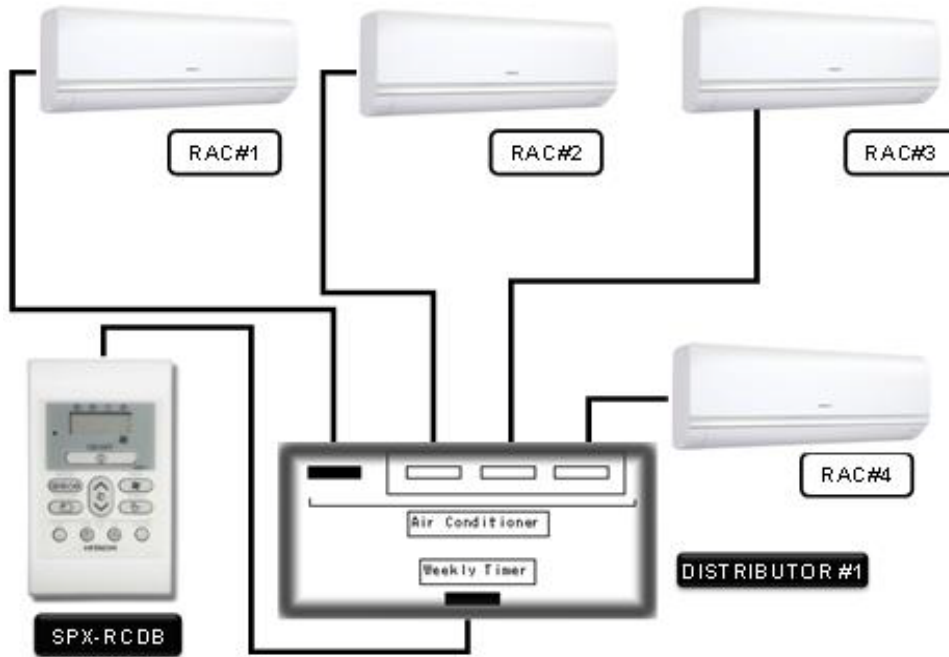

---

# HITACHI

**TC-ERP-Model (2019.02)**

**INDOOR**

**RAK-25RXE**

**RAK-35RXE**

**RAK-50RXE**

**OUTDOOR**

**RAC-25WXEN**

**RAC-35WXEN**

**RAC-50WXEN**